

Safety Solutions





Contents

Complete Safety Solutions from Banner	4
Network Technology Down to the Device Level	6
Banner In-Series Diagnostics (ISD).....	8

Hand, Finger and Body Detection

Choosing a Safety Light Curtain.....	10
S4B Type 4 Heavy-Duty Light Curtains.....	14
EZ-SCREEN LS Type 4 Heavy-Duty Light Curtains	16
EZ-SCREEN LP/30 Type 4 Light Curtains.....	20
EZ-SCREEN LP Type 4 Compact Light Curtains.....	22
SLC4 Type 4 Ultra Compact Light Curtains	24
EZ-SCREEN LS2 Type 2 Light Curtains.....	26
SGS Type 4 Safety Light Grids.....	28

Area Detection

Choosing a Safety Scanner.....	32
Safety Scanner System	36
Safety Scanner Software	39
Safety Scanner Fixed Applications.....	40
Safety Scanner Mobile Applications.....	41

Safety Relays and Controllers

Choosing a Relay and Controller.....	42
Safety Relays and Safety Controllers	46
In-Series Diagnostics Functionality	49
System Software.....	50
Safety Relay Models.....	52
Safety Controller Models.....	53

Safety Switches

Choosing a Safety Switch.....	54
Safety Switches.....	58
Non-Contact RFID Safety Switches.....	60
Enabling Devices	61
Safety Switch Models.....	62

Operator Controls

Choosing an Emergency Stop Device.....	66
E-Stop Device Models.....	70

Complete Safety Solutions from Banner



Safety Light Curtains

- Intuitive and easy-to-use and set up
- End-to-end sensing
- Heavy-duty aluminum housing and recessed window to avoid damage in harsh environments
- Highly visible alignment and diagnostic indicators
- IP69 hygienic models available for washdown environments
- Cascade capable models available
- See page 10



Safety Controllers

- Up to eight expansion I/O modules can be added as your safety application grows or changes
- Configuration software is so simple that you will be programming in minutes
- Simulator functionality allows users to test their configurations without being connected to a controller
- See page 42



Safety Laser Scanners

- Two-dimensional laser scanner with easy-to-use software
- Programming of irregular shaped warning and detection zones
- 275° scanning angle with selectable resolutions and 5.5 m range
- See page 32

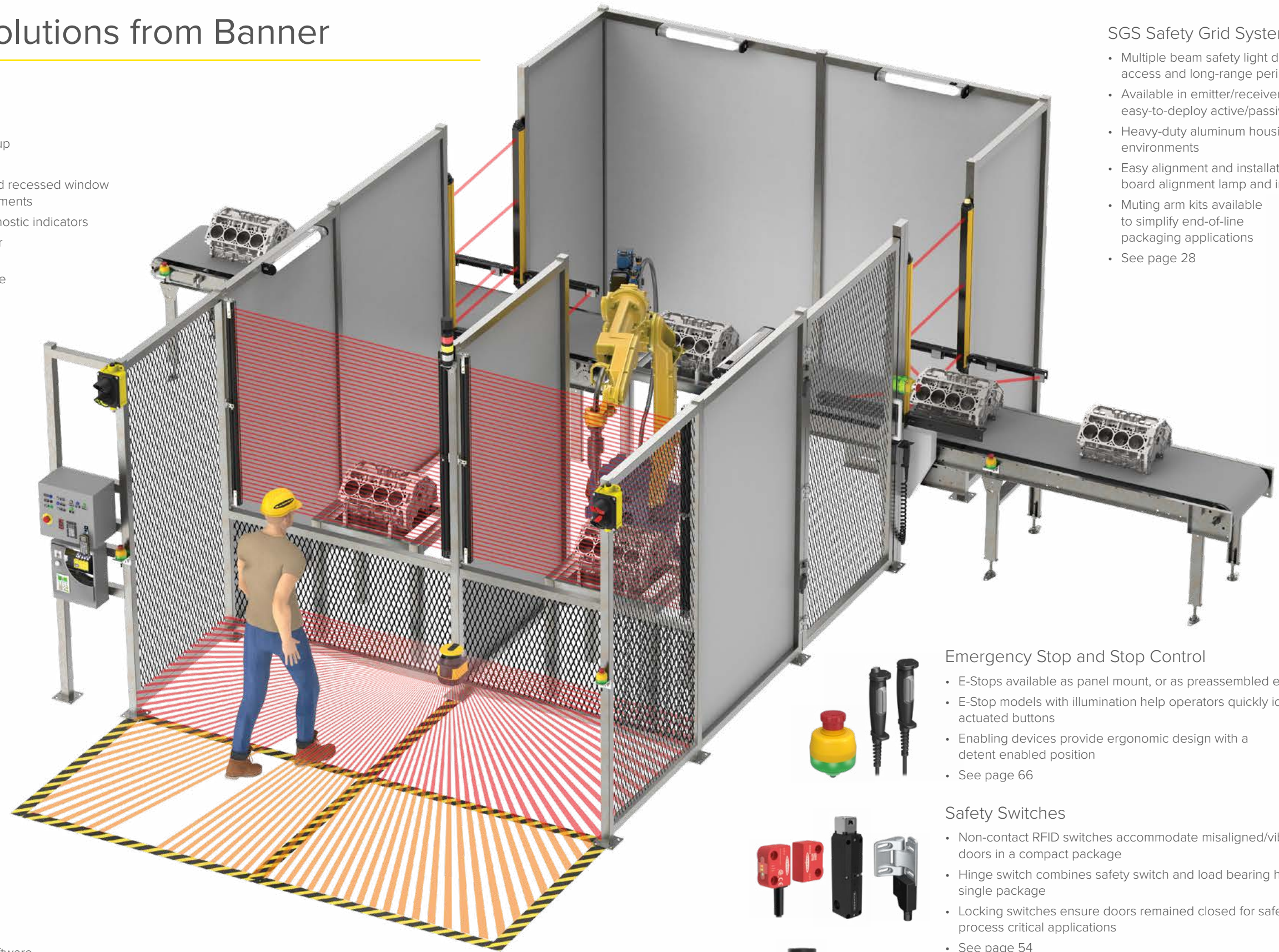

SGS Safety Grid Systems

- Multiple beam safety light devices for access and long-range perimeter guarding
- Available in emitter/receiver models and in easy-to-deploy active/passive models
- Heavy-duty aluminum housing for tough environments
- Easy alignment and installation with on-board alignment lamp and indicators
- Muting arm kits available to simplify end-of-line packaging applications
- See page 28

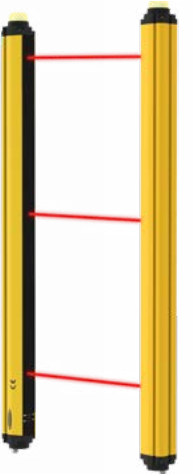

Emergency Stop and Stop Control

- E-Stops available as panel mount, or as preassembled enclosures
- E-Stop models with illumination help operators quickly identify actuated buttons
- Enabling devices provide ergonomic design with a detent enabled position
- See page 66



Safety Switches

- Non-contact RFID switches accommodate misaligned/vibrating doors in a compact package
- Hinge switch combines safety switch and load bearing hinge in a single package
- Locking switches ensure doors remained closed for safety and process critical applications
- See page 54



Lighting and Indication

- Preassembled and preconfigured multi-segment LED tower light indicators
- Programmable multicolor LED indicators, panel mount models available
- Pro Editor software offers a wide variety of color and animation options



Network Technology Down to the Device Level

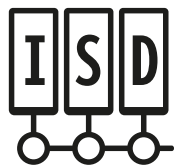
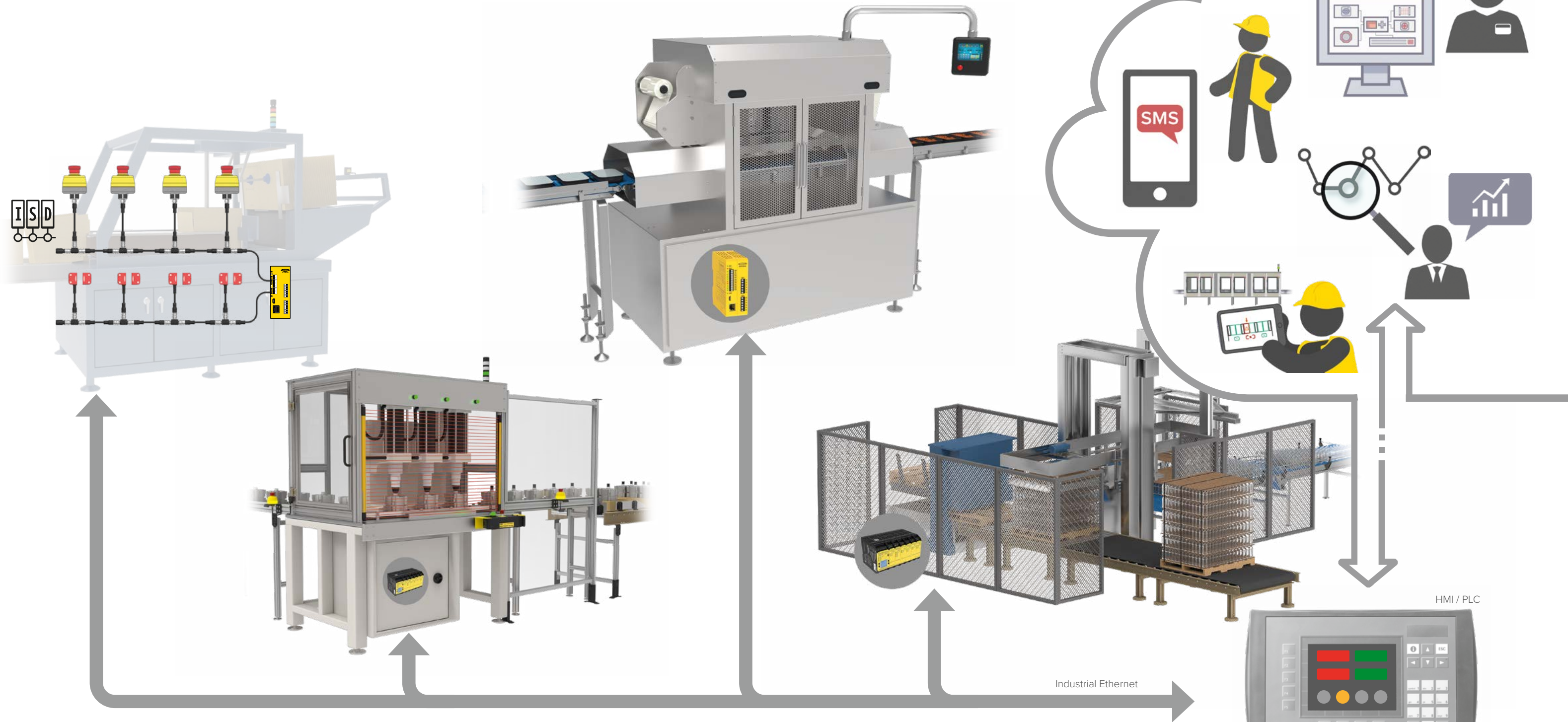

Banner In-Series Diagnostics

- Up to 32 ISD devices connected with one in-series cable communicate directly with PLC/HMI
- ISD provides an array of data including device status, voltage, temperature, RFID tag value, sensing distance, and more

1234567890

74.5°C

13.7v

Status: ON

Alignment: OK

08.0mm

Safety System Diagnostics

- Reduce downtime by quickly diagnosing safety events and displaying them on the HMI
- Prevent downtime with ISD preventive maintenance alerts

Virtual Reset

- Eliminate physical button & wires
- Reset from touch screen HMI over Industrial Ethernet

EtherNet/IP

Modbus TCP/IP

PROFIBUS NET

EtherCAT

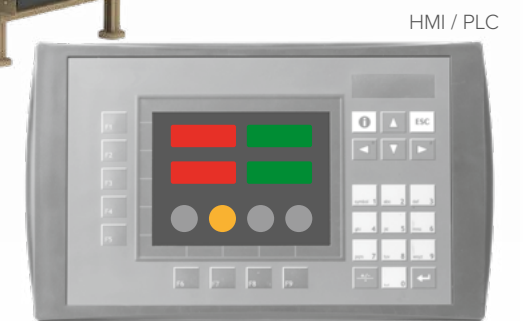

Intuitive setup and PLC integration

Free, easy-to-use PC software

- Export tag feature for easy tag creation in a PLC (patent pending)

ISD Banner In-Series Diagnostics (ISD)

Easy-to-Implement Diagnostic Capabilities for Complex Safety Systems

In-Series Diagnostics allows connection of up to 32 devices with one in-series connection and communicate directly with the most commonly used PLCs.

When a safety event occurs the system receives an alert that includes information about which safety device tripped, making troubleshooting a breeze.

In-Series Diagnostics provides an array of additional data points for each in-series device used, including a unique tag value, internal temperature, voltage, and more, along with device-specific details such as the alignment and distance between a safety switch's sensor and actuator.

Additionally, the system sends warning alarms if devices are near to tripping, so issues can be addressed before your machine shuts down.



Cut Costs



Simplify Installation & Troubleshooting





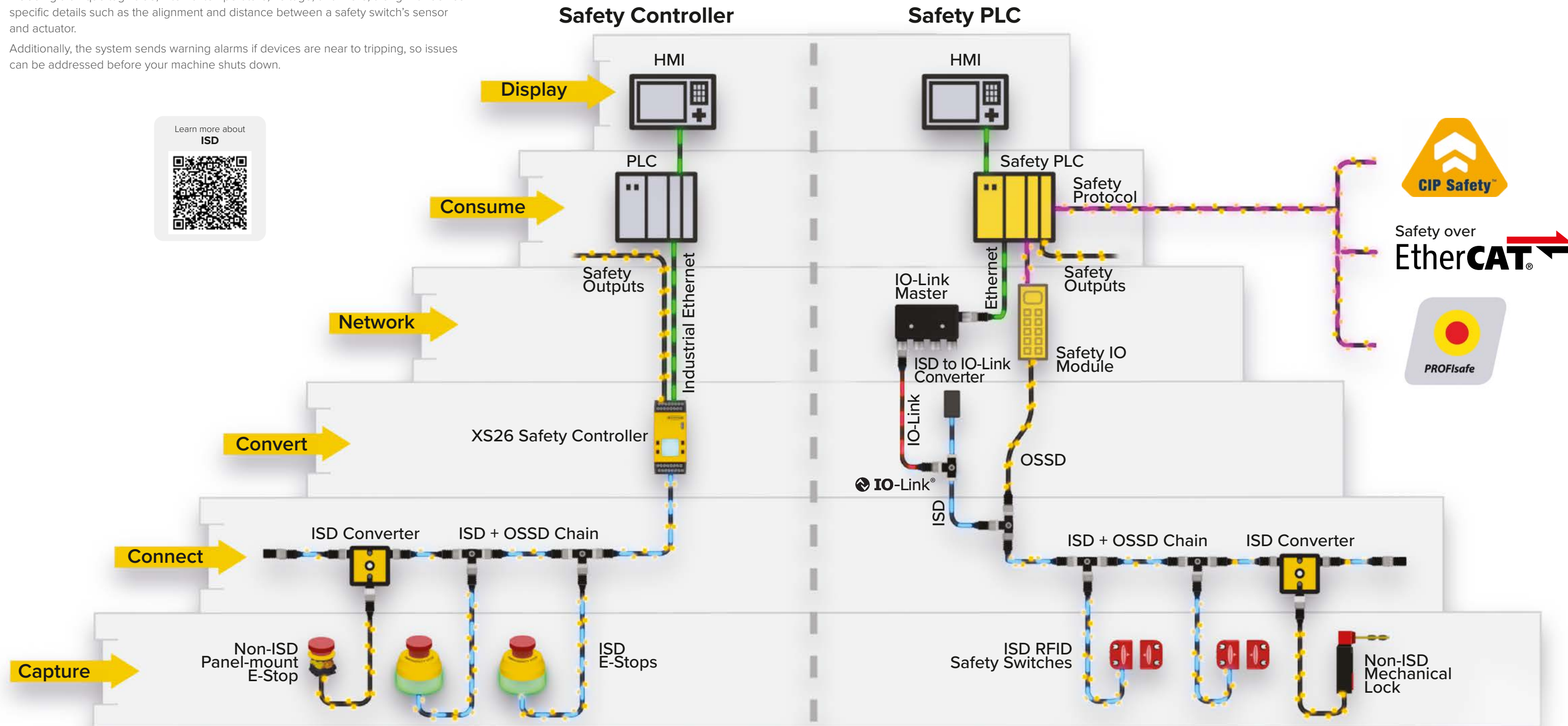



Prevent & Reduce Downtime



Choosing a Banner Safety Light Curtain



	 S4B	 EZ-SCREEN LS	 EZ-SCREEN LP	 SLC4	 EZ-SCREEN	 SGS Grids
Resolution (mm)	30	14, 23, 40	14, 25	14, 24	14, 30	300, 400, 500
Range (m)	12	12	7	2	6, 18	8, 30, 60
Defined Area (mm)	300 to 1800	280 to 2380	270 to 1250	160 to 320	150 to 2400	500 to 1200
Integral Muting			✓			✓

Safety Light Curtain Selection Guide



S4B



EZ-SCREEN LS



EZ-SCREEN 14/30



EZ-SCREEN LP



SLC4



EZ-SCREEN LS2

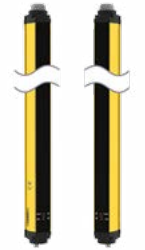

SGS Grids

	S4B	EZ-SCREEN LS	EZ-SCREEN 14/30	
	p. 14	p. 16	p. 20	
Type IEC 61496-1, -2	Type 4	Type 4	Type 4	
Safety Rating EN ISO 13849-1; IEC 61508; IEC 62061	Category 4 PL e; SIL3	Category 4 PL e; SIL3	Category 4 PL e; SIL3	
IP Rating	IP65	IP65, IP67, IP69	IP65	
Dimensions W x D (mm)	38 x 38	36 x 45	36 x 45	
Resolution (mm)	30	14, 23, 40	14	30
Max Sensing Range (m)	12	12	6	18
Defined Area (mm)	300 to 1800	280 to 2380	150 to 1800	150 to 2400
Increments (mm)	150	70	150	

	EZ-SCREEN LP	SLC4
	p. 22	p. 24
Type IEC 61496-1, -2	Type 4	Type 4
Safety Rating EN ISO 13849-1; IEC 61508; IEC 62061	Category 4 PL e; SIL3	Category 4 PL e; SIL3
IP Rating	IP54, IP65	IP65
Dimensions W x D (mm)	28 x 26	27 x 22
Resolution (mm)	14, 25	14, 24
Max Sensing Range (m)	Basic: 4 Standard: 7	2
Defined Area (mm)	Basic: 270, 410, 550, 690 Standard: 270 to 1250	160, 240, 320
Increments (mm)	Standard: 140	80

	EZ-SCREEN LS2
	p. 26
Type IEC 61496-1, -2	Type 2
Safety Rating EN ISO 13849-1; IEC 61508; IEC 62061	Category 2 PL c
IP Rating	IP65
Dimensions W x D (mm)	25 x 32
Resolution (mm)	30
Max Sensing Range (m)	15
Defined Area (mm)	150 to 1800
Increments (mm)	150

	SGS Grids
	p. 28
Type IEC 61496-1, -2	Type 4
Safety Rating EN ISO 13849-1; IEC 61508; IEC 62061	Category 4 PL e; SIL3
IP Rating	IP65
Dimensions W x D (mm)	52 x 56.9
Resolution (mm)	300, 400, 500
Max Sensing Range (m)	Standard: 30 Long Distance: 60
Defined Area (mm)	500 to 1200
Increments (mm)	2, 3, 4 Beams

Functions	S4B	EZ-SCREEN LS	EZ-SCREEN 14/30
Hand Detection	✓	✓	✓
Finger Detection		✓	✓
Body Detection			
Cascade		SLLC	SLSC
Scan Codes	✓	✓	✓
Fixed Blanking		✓	✓
Reduced Resolution			✓
EDM		✓	✓
Reset			✓
Integrated Muting		See page 18	
LED on Top		Accessory	

Functions	EZ-SCREEN LP	SLC4
Hand Detection	✓	✓
Finger Detection	✓	✓
Body Detection		
Cascade	SLPC	
Scan Codes	✓	
Fixed Blanking	✓	
Reduced Resolution	✓	
EDM	✓	
Reset	✓	
Integrated Muting	✓	
LED on Top		

Functions	EZ-SCREEN LS2
Hand Detection	✓
Finger Detection	
Body Detection	
Cascade	
Scan Codes	
Fixed Blanking	
Reduced Resolution	
EDM	✓
Reset	✓
Integrated Muting	
LED on Top	

Functions	SGS Grids
Hand Detection	
Finger Detection	
Body Detection	✓
Cascade	
Scan Codes	✓
Fixed Blanking	
Reduced Resolution	
EDM	✓
Reset	✓
Integrated Muting	✓
LED on Top	✓

S4B Type 4 Heavy-Duty Light Curtains

Designed for a broad range of applications, the next generation of safety light curtains has essential features including remote indication for predictive maintenance.

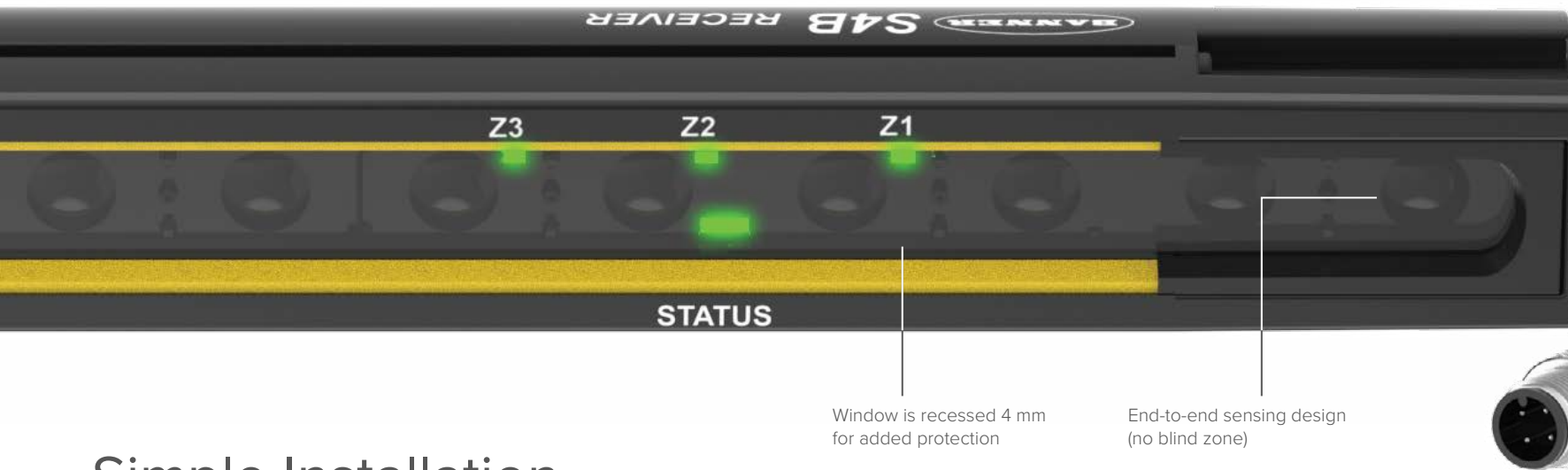

Window is recessed 4 mm for added protection

End-to-end sensing design (no blind zone)

Prevent Downtime

Yellow indicates a weak signal due to a dirty lens. A weak beam strength output is sent via pin 5 to a PLC or HMI alerting operators to preventive maintenance needs.

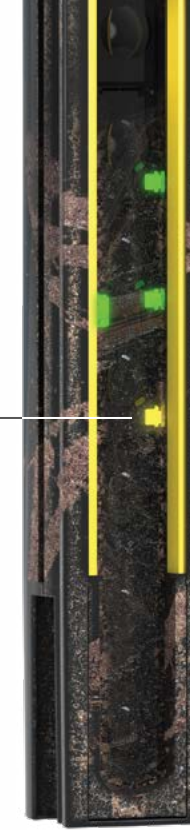

Eliminate Costly Repairs

Removable cordset with 5-pin M12 QD allows for cost effective replacement of only the damaged component

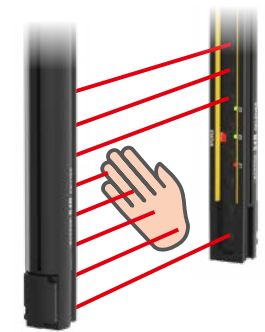

Reliable Hand Detection

The S4B features a 30-millimeter resolution for reliable hand detection

Simple Installation

The S4B is designed and optimized for easy and intuitive installation, operation, and troubleshooting. Zone LEDs aid troubleshooting and help reduce downtime.

Alignment Zone Indicators

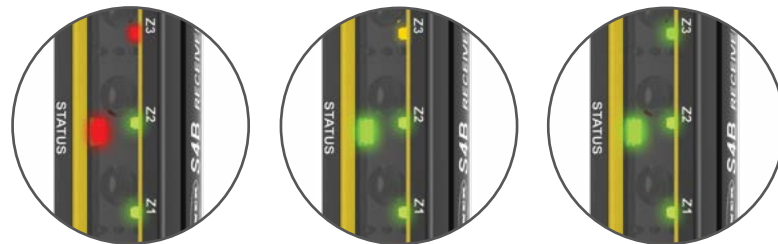

Misaligned
Red indicates a loss of signal due to a blocked beam or significant misalignment

Weak
Yellow indicates a weak signal due to a slight misalignment

Aligned
Green indicates a strong signal, proper alignment, and clear of obstruction

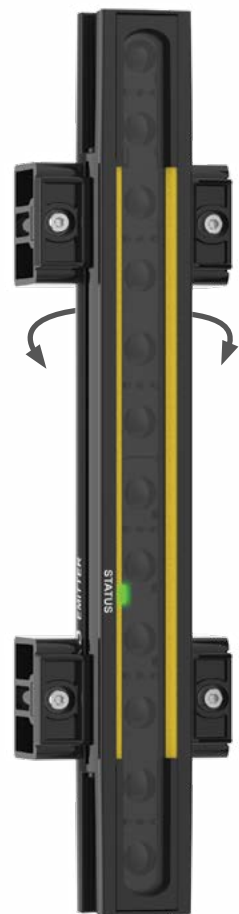

Rotating and locking brackets



Intuitive Setup and Swap-out

Select and save scan code setting without a PC for easy setup and swap-out



1. Select Emitter and Receiver

Family	Feature Set	Device Type	Resolution	Defined Area	Termination
S4	B	E	30	900	S
	B = Basic	E = Emitter only R = Receiver only	30 = 30 mm	300 = 300 mm 450 = 450 mm 600 = 600 mm 750 = 750 mm 900 = 900 mm 1050 = 1050 mm 1200 = 1200 mm 1350 = 1350 mm 1500 = 1500 mm 1650 = 1650 mm 1800 = 1800 mm	S = Emitter or Receiver only (S4B bracket(s) and S4B cordset(s) sold separately)

2. Add S4B Brackets (required)



S4BA-MBK-16

- Side mount bracket
- Rotation: +/- 15°
- Includes 2 brackets and hardware
- Each bracket supports 900 mm of length

3. Add S4B Cordsets (required)



DES4E-51D

- S4B removable 5-pin M12 QD pigtail
- Includes one

EZ-SCREEN LS Type 4 Heavy-Duty Light Curtains

The LS is a full-feature family of light curtains providing greater capabilities for cascading, blanking, EDM and more.

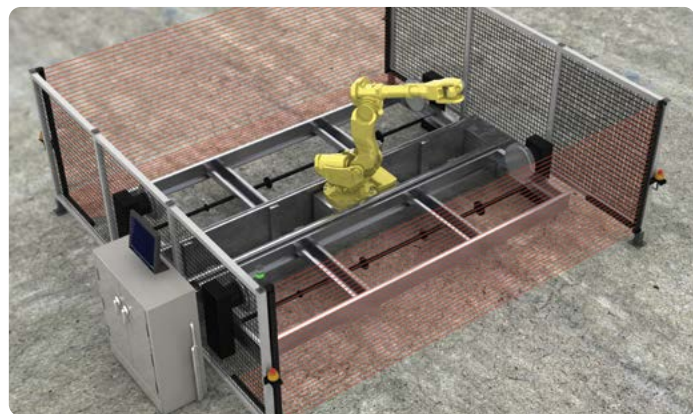
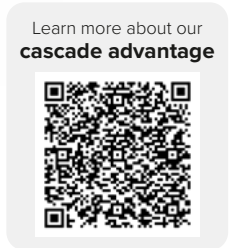
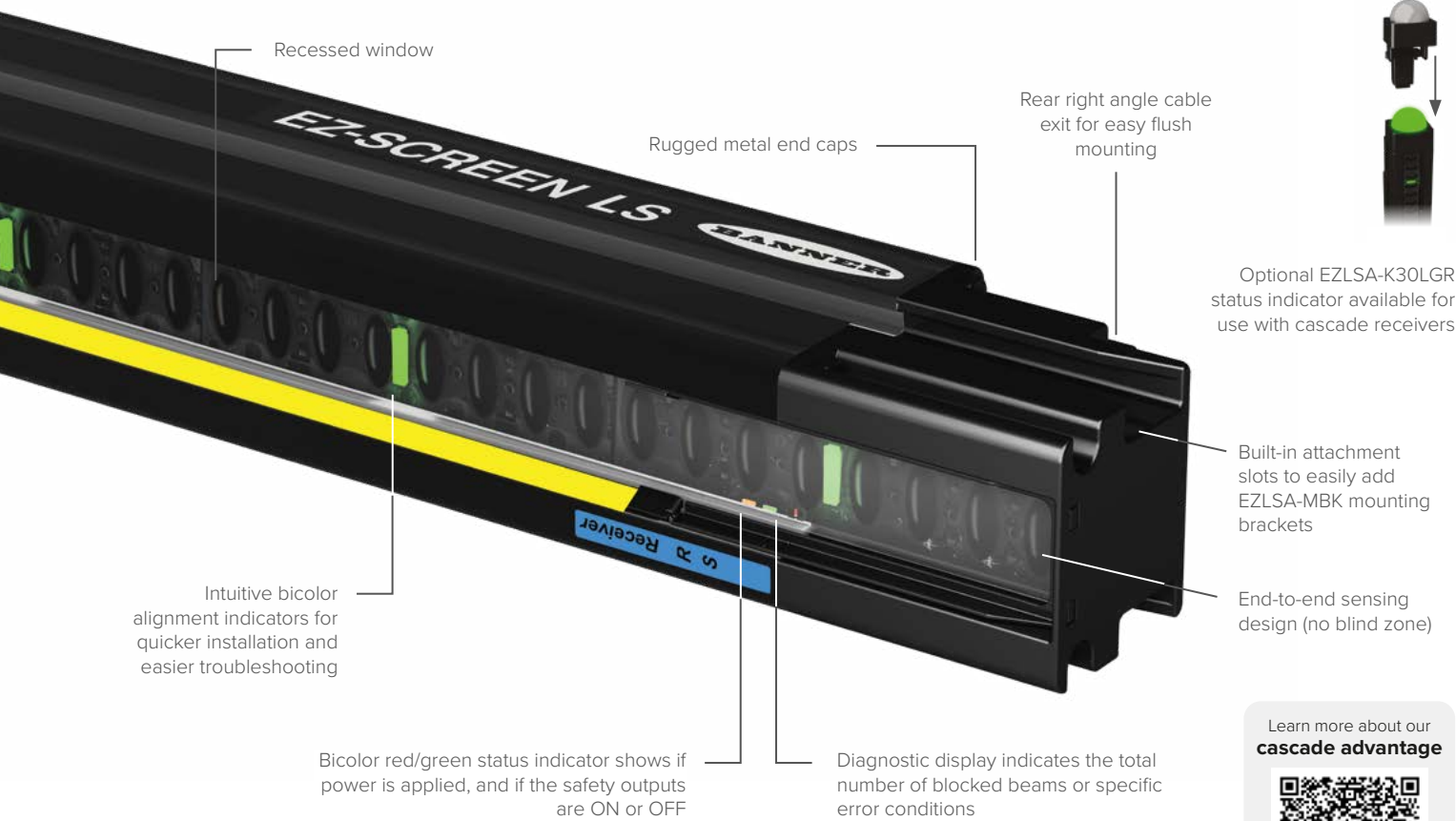

Due to its robust design, the EZ-SCREEN LS is the perfect fit in large robotic cell applications that require sturdy safety devices and heavy duty enclosures.



EZ-SCREEN LS light curtains in hygienic tubular enclosures successfully protect operators from injury and remain hygienic for easy cleaning procedures.

1. Select Emitter, Receiver, or Pair

Family	Cascade	System Type	Resolution	Defined Area	Termination	
SLL		E	14	910	S	
	Blank = Standard C = Cascade	E = Emitter only R = Receiver only P = Pair (Emitter and Receiver)	14 = 14 mm 23 = 23 mm 40 = 40 mm	280 = 280 mm* 350 = 350 mm 420 = 420 mm 490 = 490 mm 560 = 560 mm 630 = 630 mm 700 = 700 mm 770 = 770 mm 840 = 840 mm	910 = 910 mm 980 = 980 mm 1050 = 1050 mm 1120 = 1120 mm 1190 = 1190 mm 1260 = 1260 mm 1330 = 1330 mm 1400 = 1400 mm 1470 = 1470 mm	1540 = 1540 mm 1610 = 1610 mm 1680 = 1680 mm 1750 = 1750 mm 1820 = 1820 mm 1960L = 1960 mm** 2100L = 2100 mm** 2380L = 2380 mm**

*Not available in cascade models
**23 mm resolution, IP65, 10 m range

S = emitter or receiver only (LS bracket(s) and LS cordset(s) ordered separately)
P5 = Emitter or receiver includes one LS M12 double ended cordset (5-pin) and LS brackets (-11 and -12)
P55 = Pair includes two LS M12 double ended cordsets (5-pin) and LS brackets (-11 and -12)
P8 = Emitter or receiver includes one LS M12 double ended cordset (8-pin) and LS brackets (-11 and -12)
P88 = Pair includes two LS M12 double ended cordsets (8-pin) and LS brackets (-11 and -12)
Blank = Emitter, receiver or pair includes LS brackets (-11 and -12), LS cordset ordered separately

2. Add LS Brackets (for "-S" termination)



EZLSA-MBK-11

- End mount slotted steel bracket
- Rotation: 360° in 23° increments
- Includes two brackets
- Slotted mounting holes spaced 20 mm on-center



EZLSA-MBK-12

- Center mount steel bracket
- Rotation: +/- 15°
- Includes one bracket
- Use with EZLSA-MBK-11/-20 with a max of 980 mm unsupported



EZLSA-MBK-16

- Side mount die-cast bracket
- Rotation: +15° and -20°
- Includes one bracket
- Use one or multiple with a max of 980 mm unsupported



EZLSA-MBK-20

- End mount universal steel bracket
- Rotation: 360° in 23° increments
- Includes two brackets
- Universal mounting slots

3. Add LS Cordsets (for "-S" or "Blank" termination)



LS-Custom to M12 Double Ended

- DELSE-51D (5-Pin)**
0.3 m (1')
- DELSE-81D (8-Pin)**
0.3 m (1')



Single Ended LS-Custom to Flying Leads

- RDLS-515D (5-Pin)**
4.6 m (15')
- RDLS-815D (8-Pin)**
4.6 m (15')
- RDLS-825D (8-Pin)**
8 m (26')
- RDLS-850D (8-Pin)**
15.3 m (50')



Double-Ended RD to RD Cordsets for Cascade Systems

- DELS-111E**
0.3 m (1')
- DELS-113E**
1 m (3.3')
- DELS-1115E**
4.6 m (15.1')

IP69 Hygenic

Family	System Type	Resolution	Defined Area		Termination
EZLSA-HTE	R	23	910		
	E = Emitter R = Receiver	23 = 23 mm	280 = 280 mm* 350 = 350 mm 420 = 420 mm 490 = 490 mm 560 = 560 mm 630 = 630 mm	700 = 700 mm 770 = 770 mm 840 = 840 mm 910 = 910 mm 980 = 980 mm 1050 = 1050 mm	Blank = 7.6 m, 8-wire high durometer PVC cordset F = Remote Fixed Blanking Receiver model with additional 7.6 m cordset for blanking configuration
*Not available with remote fixed blanking option					



Brackets



EZLSA-MBK-HTE-1

- Stamped stainless steel bracket
- 360° rotation for IP69 enclosure models
- Two brackets per optional kit



EZLSA-MBK-HTE-2

- Hygienic stainless steel bracket
- 360° rotation for IP69 enclosure models
- Two brackets per optional kit

Mute Arm Kits

Create a turn-key muting solution for your EZ-SCREEN LS Safety Light Curtain

- With a 300 mm (1 ft) PVC cable with a 8-pin M12 male quick disconnect
- **Needs EZ-SCREEN LS Hardware Adaptor Kit EZLSA-MCB-HW**

L-Configuration

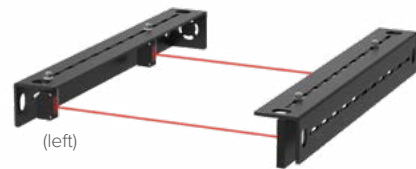

SGSA-ML-L-LPQ20

Includes 2 mute arms, 2 SGSA-Q20PLPQ5 mute sensors, and 2 retroreflectors

T-Configuration

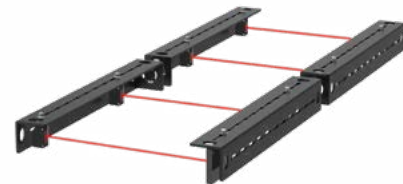

SGSA-MT-LPQ20

Includes 4 mute arms, 4 SGSA-Q20PLPQ5 mute sensors, and 4 retroreflectors

X-Configuration

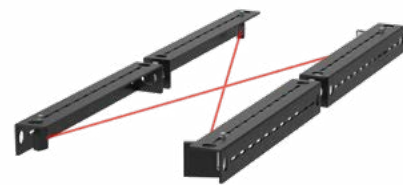

SGSA-MX-LPQ20

Includes 4 mute arms, 2 SGSA-Q20PLPQ5 mute sensors, and 2 retroreflectors

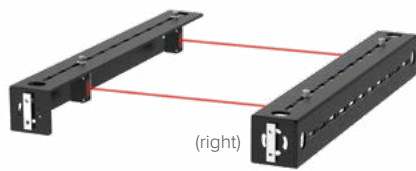

SGSA-ML-R-LPQ20

Includes 2 mute arms, 2 SGSA-Q20PLPQ5 mute sensors, and 2 retroreflectors

Muting System Diagram

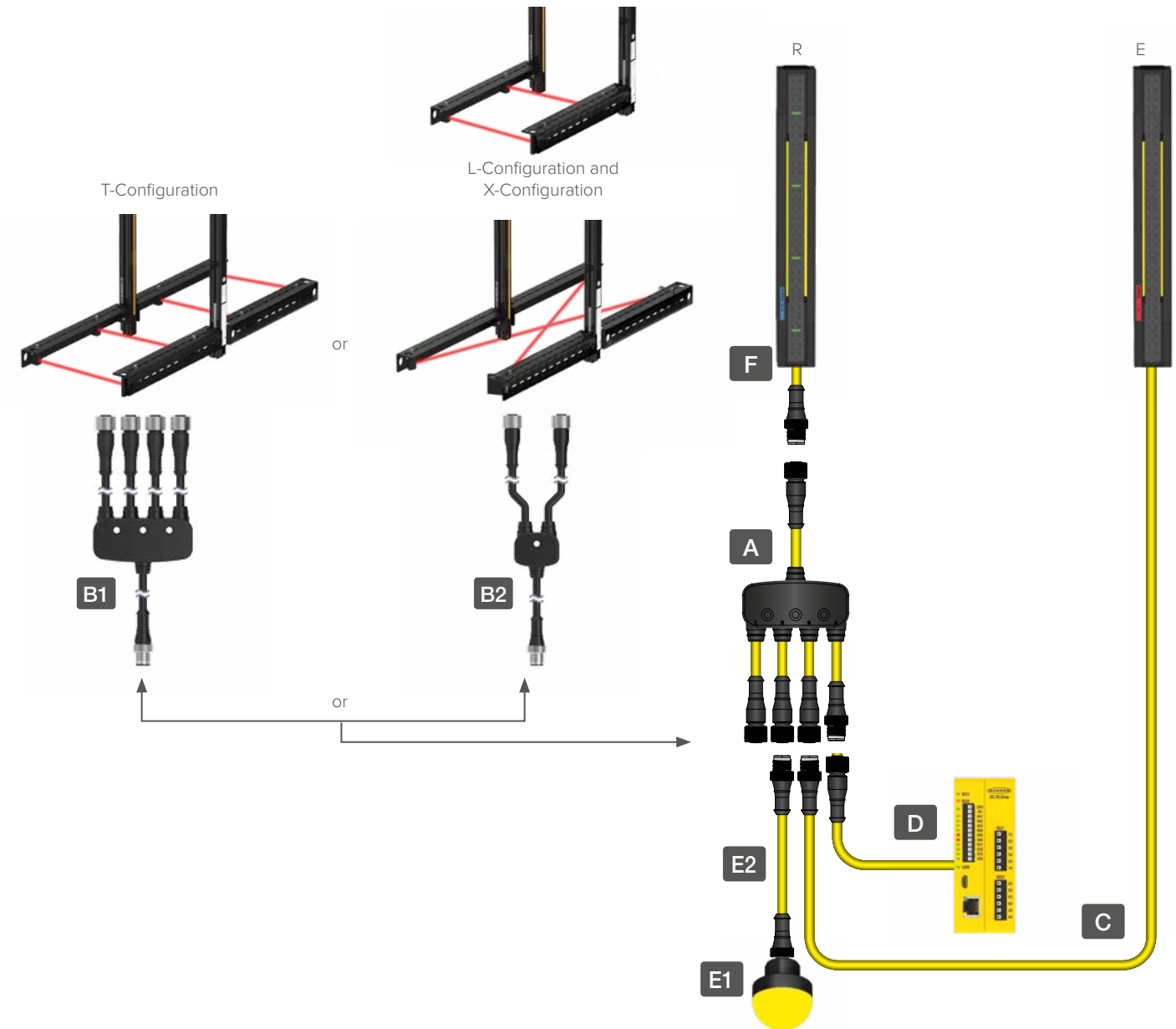

Connection Cables

A	CSM4-M1281M1251M1281 LS muting connection cable
B	SGS mute arm kit connection cable (select one) B1: T-Muting: CSA4-M1251M1251M1251M1251 B2: L-Muting or X-Muting: CSA-M1241M1241
C	DEE2R-8xxD LS emitter connection cable (xx is the length in feet)
D	QDEG-12xxE Safety controller connection cable (xx is the length in feet)
F	DELSE-81D (8-Pin) LS receiver connection cable (M12)

Mute Lights and Cables

E1	TL50WQ, TL50YQ, K50LWXXPQ, K50LYXXPQ Mute lights (xx is the length in feet)
E2	DEE2R-5xx Mute light cable (xx is the length in feet)

Interface options

Interface Modules (see page 52)

EZ-SCREEN 14/30 Type 4 Light Curtains

Banner's traditional light curtain, the EZ-Screen 14/30 provides the longest sensing range, reduced resolution, and includes trip or latch/reset functionality.



Offers optional cascading to create a system that responds to a single stop command

Learn more about our **cascade advantage**



1. Select Emitter and Receiver

Family	Cascade	System Type	Resolution	Defined Area		Finish	Termination
SLS	C	P	14	150			Q88
	C = Cascade Blank = No cascading	E = Emitter R = Receiver P = Pair	14 = 14 mm 30 = 30 mm	150 = 150 mm* 300 = 300 mm 450 = 450 mm 600 = 600 mm 750 = 750 mm 900 = 900 mm 1050 = 1050 mm 1200 = 1200 mm	1350 = 1350 mm 1500 = 1500 mm 1650 = 1650 mm 1800 = 1800 mm 1950 = 1950 mm** 2100 = 2100 mm** 2250 = 2250 mm** 2400 = 2400 mm**		
<small>*Not available in cascade models **Only available in 30 mm resolution</small>							
Blank = Yellow powder coat N = Nickel-plated ESD <small>(ESD-safe models are not available with pigtail QD)</small> A = Clear anodized aluminium							
Q8 = 8-pin M12 QD (individual Emitter or Receiver models) P8 = 8-pin M12 pigtail QD (individual Emitter or Receiver models) Q88 = For Pair – Emitter with 8-pin M12 QD, Receiver with 8-pin QD P88 = For Pair – Emitter with 8-pin M12 pigtail QD, Receiver with 8-pin M12 pigtail QD							

2. Add Brackets



EZA-MBK-11

- Standard mounting L-bracket



EZA-MBK-12

- Center mounting bracket



EZA-MBK-20

- Retrofit bracket for mounting to engineered/slotted aluminum framing



EZA-MBK-21

- Mounting bracket system for L configuration of two cascaded light screens
- One EZA-MBK-21 kit contains brackets for one side of an L-mounting configuration

EZ-SCREEN LP Type 4 Compact Light Curtains

Banner's compact full-feature family of light curtains providing capabilities for cascading, blanking, integral muting, latch/reset, EDM, and more.

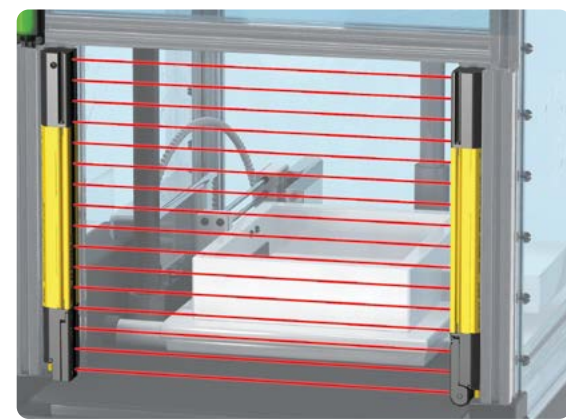
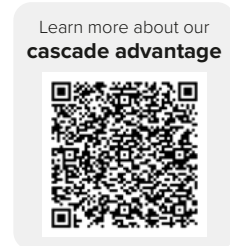
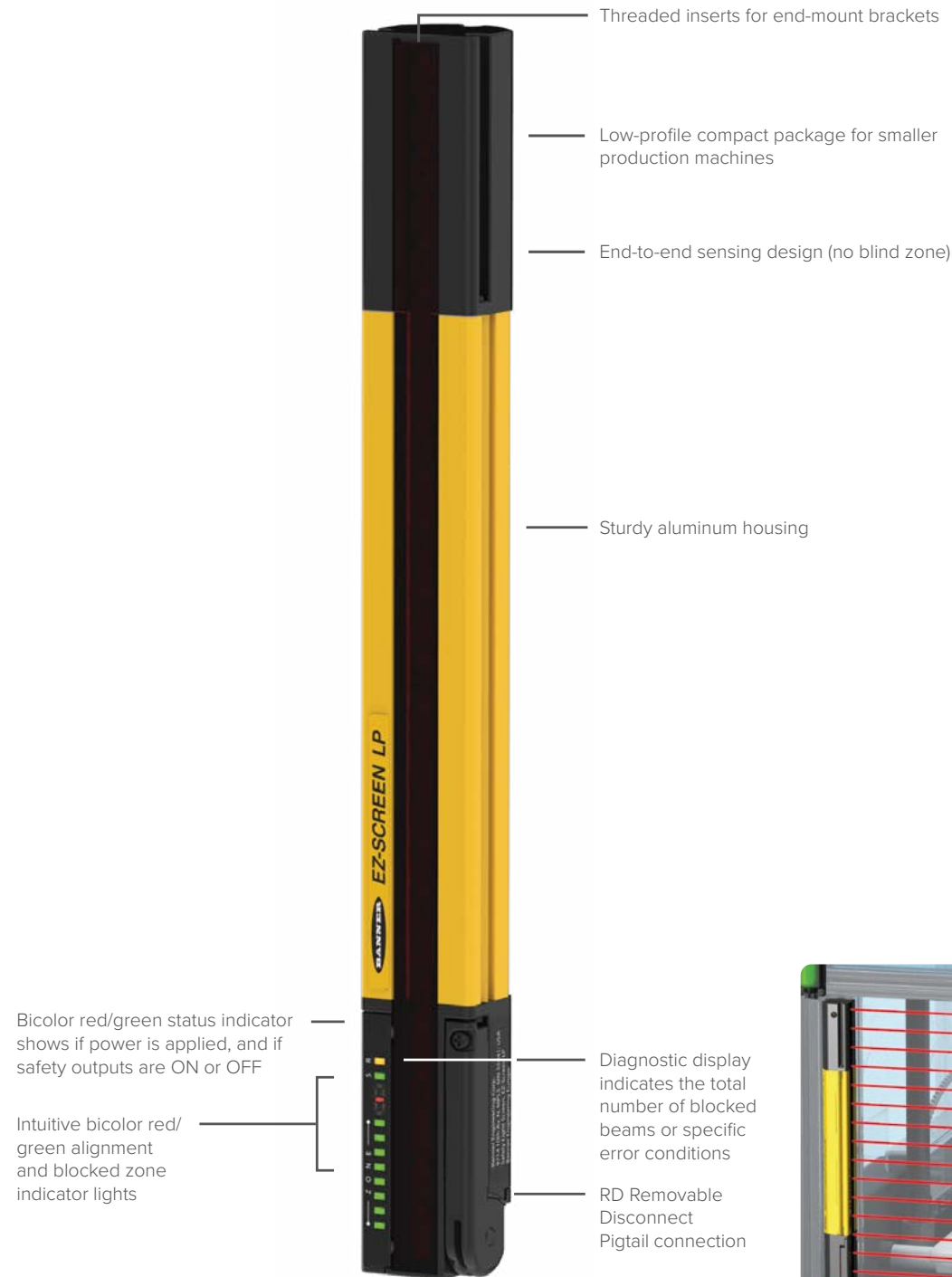

The EZ-SCREEN LP safety light screen is compact and mounts in tight spaces with its continual end-to-end sensing that leaves no gaps.

1. Select Emitter and Receiver

EZ Screen LP

Family	Cascade	System Type	Resolution	Defined Area	Termination
SLP	C	P	14	— 410	P88
	C = Cascade* Blank = Standard VA = LP Basic	P = Pair (Emitter and Receiver) E = Emitter only R = Receiver only	14 = 14 mm 25 = 25 mm	270 = 270 mm** 410 = 410 mm 550 = 550 mm 690 = 690 mm	830 = 830 mm† 970 = 970 mm† 1110 = 1110 mm† 1250 = 1250 mm†
<p>Note: LP Basic contains individual emitter and/or receiver only. Brackets and cordset ordered separately</p> <p>P8 = 300 mm 8-Pin M12 pigtail QD (individual Emitter or Receiver models) P88 = 300 mm 8-Pin M12 pigtail QD (on BOTH Emitter and Receiver models) Blank = no pigtail, RD connection (for RDLP-8..D cordset)</p> <p>*8-pin connection required for cascade models and to enable EDM, Aux Output and Reset features **Not available in cascade models †Not available in LP Basic models</p>					

EZ Screen LP with Muting

Family	Resolution	Defined Area	Finish	Termination	
SLPMP	14	— 410			
SLPE = Emitter SLPMR = Receiver SLPMP = Pair	14 = 14 mm 25 = 25 mm	410 = 410 mm 550 = 550 mm 690 = 690 mm 830 = 830 mm	410 = 410 mm 970 = 970 mm 1110 = 1110 mm 1250 = 1250 mm	Blank = Yellow powder coat N = Nickel-plated ESD A = Clear anodized aluminium	Blank = Integral Removable Disconnect P8 = 8-pin pigtail QD (SLPE) P12 = 12-pin pigtail QD (SLPMR) P128 = For SLPMP (Pair) Emitter with 8-pin M12 pigtail QD Receiver with 12-pin M12 pigtail QD

2. Add Brackets

LPA-MBK-10	LPA-MBK-11	LPA-MBK-12	LPA-MBK-16	LPA-MBK-21	LP-Custom to M12 Male QD
<ul style="list-style-type: none"> End mount bracket Rotation: 40° Includes 2 brackets and hardware 14 ga. steel, black zinc-plated 	<ul style="list-style-type: none"> Standard end mount bracket Rotation: 360° Includes 2 brackets and hardware 14 ga. steel, black zinc-plated 	<ul style="list-style-type: none"> Standard side mount bracket Rotation: +10° and -30° Includes 1 bracket and hardware 14 ga. steel, black zinc-plated 	<ul style="list-style-type: none"> Side mount bracket Rotation: +15° and -20° Includes 1 bracket and hardware Black zinc die-cast 	<ul style="list-style-type: none"> Pivoting cascade mounting bracket Includes 2 brackets and hardware 14 ga. steel, black zinc-plated 	<ul style="list-style-type: none"> DELPE-51D (5-pin) 0.3 m (1 ft) DELPE-81D (8-pin) 0.3 m (1 ft)

3. Add Cordsets

SLC4 Type 4 Ultra Compact Light Curtains

Banner's shortest, most compact light curtain is built with today's essential features including 14 mm and 24 mm resolution, zone/alignment indicators, and more.

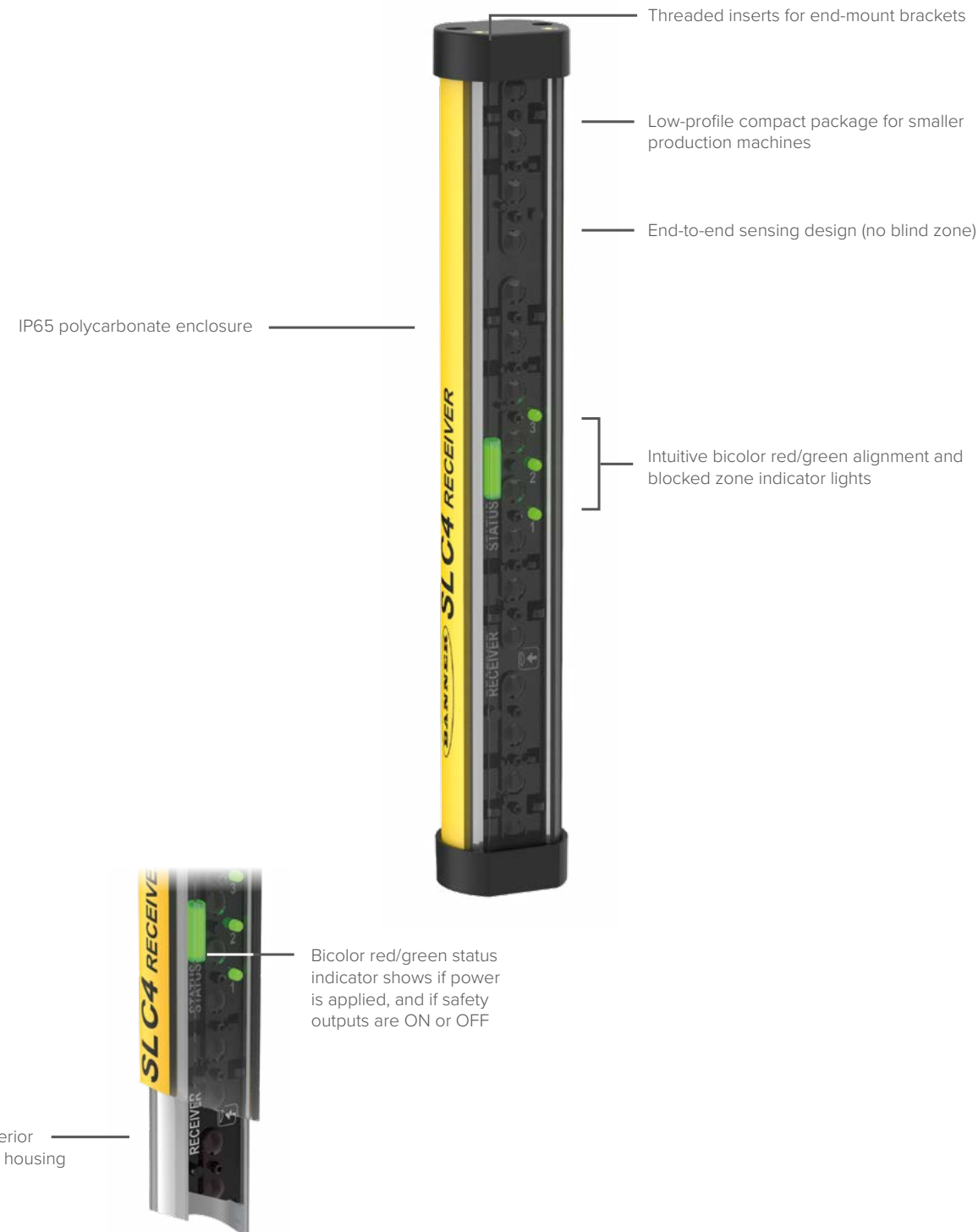

1. Select Emitter and Receiver

Family	System Type	Resolution	Defined Area	Termination
SLC4	P	14	160	P44
	P = Pair (Emitter and Receiver) E = Emitter only R = Receiver only	14 = 14 mm 24 = 24 mm	160 = 160 mm 240 = 240 mm 320 = 320 mm	P4 = 300 mm 4-Pin M12 pigtail QD (individual Emitter or Receiver models) P44 = 300 mm 4-Pin M12 pigtail QD (Pair)

2. Add Brackets

SLC4A-MBK-10	SLC4A-MBK-11	SLC4A-MBK-12
<ul style="list-style-type: none"> End mount bracket Rotation: +/- 20° Includes 4 brackets and hardware 14 ga. steel, black zinc-plated 	<ul style="list-style-type: none"> End mount bracket Rotation: Fixed Includes 4 brackets and hardware Glass-filled polycarbonate 	<ul style="list-style-type: none"> Side mount bracket Rotation: +/- 15° Includes 2 brackets Glass-filled polycarbonate

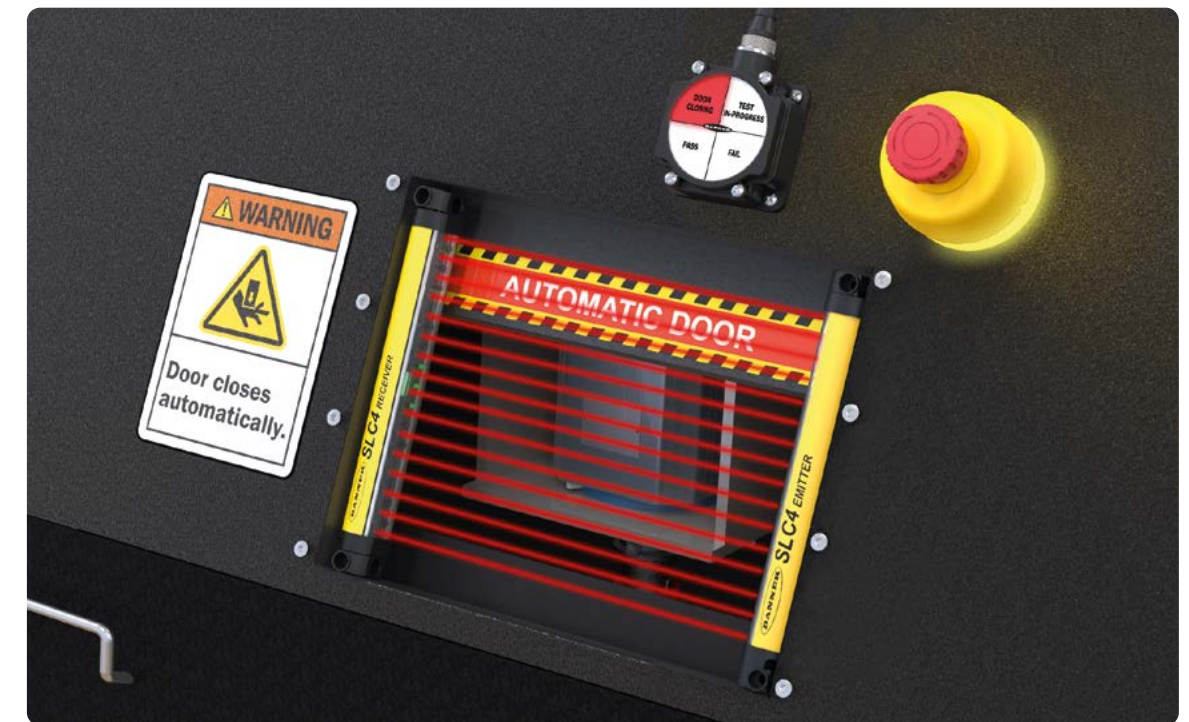

SLC4 are Type 4 safety light curtains specifically designed to safeguard smaller points of operation and access on compact machines.

EZ-SCREEN LS2 Type 2 Light Curtains

Designed for lower-risk applications such as bump or bruise, knock-down, trapping but not crushing, or minor cuts and abrasions.



1. Select Emitter and Receiver

Family	System Type	Resolution	Defined Area		Termination
LS2	TP	30	150		Q88
	E = Emitter TR = Trip Receiver TP = Trip Pair LR = Latch Receiver LP = Latch Pair	30 = 30 mm	150 = 150 mm 300 = 300 mm 450 = 450 mm 600 = 600 mm 750 = 750 mm 900 = 900 mm	1050 = 1050 mm 1200 = 1200 mm 1350 = 1350 mm 1500 = 1500 mm 1650 = 1650 mm 1800 = 1800 mm	Q8 = 8-pin QD (individual Emitter or Receiver models) Q88 = For pair: Emitter with 8-pin M12 QD, Receiver with 8-pin M12 QD

2. Add Brackets



USMB-5

- Retrofit mounting bracket
- 2.3 mm thickness, black zinc-plated, chromate dip finish
- Mounting hardware included: 1 kit required per emitter or receiver



USMB-6

- Universal mounting bracket kit
- 2.3 mm thickness, black zinc-plated, chromate dip finish
- Mounting hardware included: 1 kit required per emitter or receiver



USMB-8

- Low profile mounting plate for 90° sensor direction
- Black anodized aluminum
- Uses two M4 screws (user supplied) for through-hole mounting
- 1 kit required per emitter or receiver



8-Pin M12 with Flying Leads

- **QDE-815D**
4.5 m (15')
- **QDE-825D**
7.6 m (25')
- **QDE-850D**
15.2 m (50')



The Type 2 EZ-SCREEN safety light screen protects hands and fingers from being bumped, bruised, or pinched by the moving parts of a carousel.

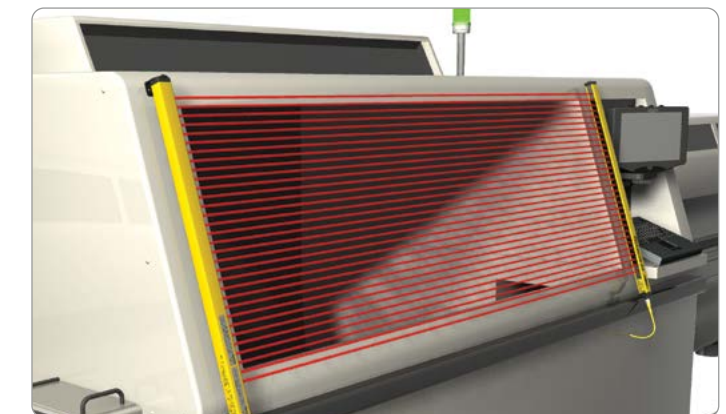

The Type 2 EZ-SCREEN safety light screen guards the opening to a chip shooter, which has moving parts that can cause painful but usually temporary injuries.

SGS Type 4 Safety Light Grids

Two to four beam Type 4 safety light grids protect personnel from injury and machines from damage by guarding access, areas, and perimeters. Able to detect a body in a cost-effective and heavy-duty safety light curtain package.

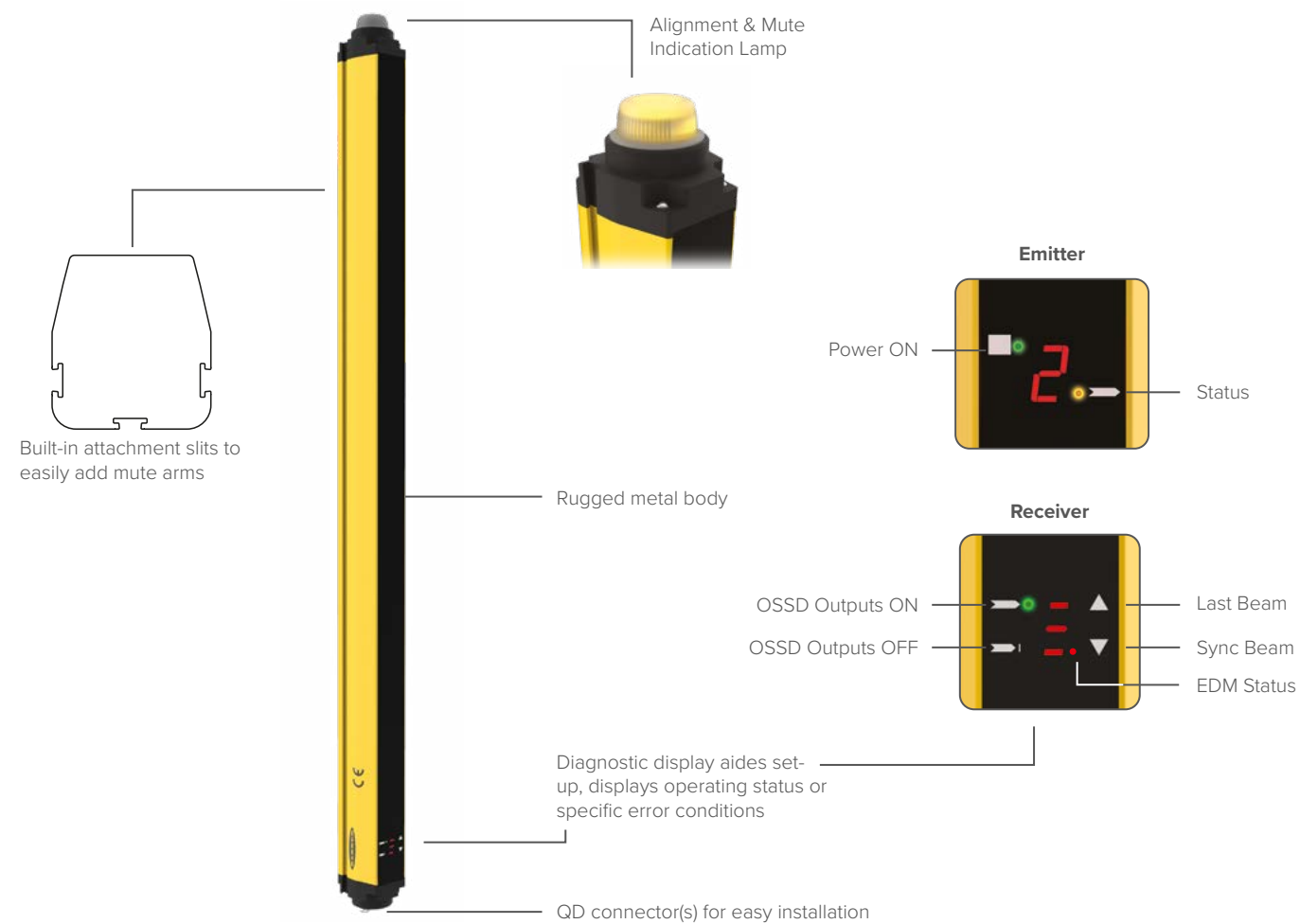

SGS Safety Grid Systems, with two, three, or four beams, are used to monitor the perimeter of the work area.



SGS Safety Grid Systems are available in Emitter/Receiver models capable of safeguarding over very long distances and in easy-to-deploy Active/Passive models.

SGS Emitter/Receiver

- When compared to higher resolution light screens, a lower cost option for body detection applications
- Available with integral muting
- Long range, up to 60 m

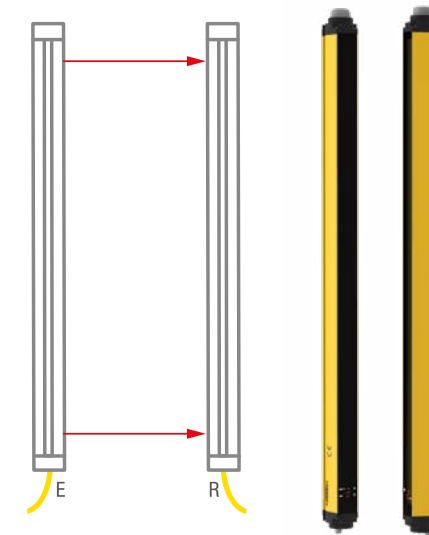

Type	Range (m)	Integral Muting	Protective Height (mm)	Models
Emitter & Receiver	6 to 60	No	500 (2 beams)	SGSXP2-500Q88
			800 (3 beams)	SGSXP3-400Q88
			900 (4 beams)	SGSXP4-300Q88
			1200 (4 beams)	SGSXP4-400Q88
	0.5 to 30	No	500 (2 beams)	SGSSP2-500Q88
			800 (3 beams)	SGSSP3-400Q88
			900 (4 beams)	SGSSP4-300Q88
			1200 (4 beams)	SGSSP4-400Q88
	0.5 to 30	Yes	500 (2 beams)	SGSMP2-500Q128
			800 (3 beams)	SGSMP3-400Q128
			900 (4 beams)	SGSMP4-300Q128
			1200 (4 beams)	SGSMP4-400Q128

SGS Active/Passive

- Active transceiver contains emitter and receiver
- Reduces overall wiring costs
- Available with integral muting
- Up to 8 m range

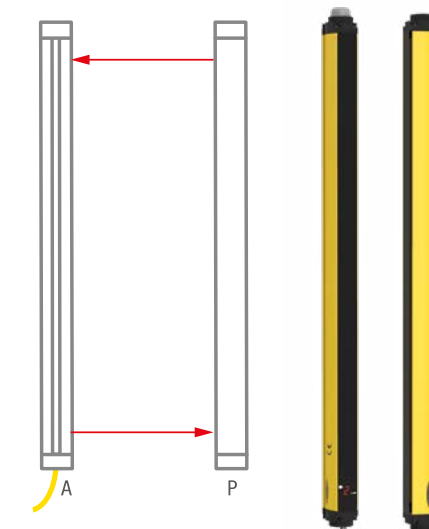

Type	Range (m)	Integral Muting	Protective Height (mm)	Models
Active Transceiver	0.5 to 8	No	500 (2 beams)	SGSSA2-500Q8
			800 (3 beams)	SGSSA3-400Q8
			900 (4 beams)	SGSSA4-300Q8
	0.5 to 8	Yes	500 (2 beams)	SGSMA2-500Q12
			800 (3 beams)	SGSMA3-400Q12
			900 (4 beams)	SGSMA4-300Q12
			1200 (4 beams)	SGSMA4-400Q12

Passive Mirror

Type	Range (m)	Protective Height (mm)	Models
Passive Mirror Assembly	Pair with Active Transceivers with matching beams and protective heights	500 (2 beams)	SGSB2-500
		800 (3 beams)	SGSB3-400
		900 (4 beams)	SGSB4-300
		1200 (4 beams)	SGSB4-400

Mute Arm Kits

Preassembled (with mounting hardware) for plug-and-play connection to the SGS grid and LS Safety Light Curtains

- Wiring connection block or cable accessories available
- Adjusts easily for line changes
- Hardware kit to attach mute arms to LS curtains, EZLSA-MCB-HW, ordered separately from mute arm kits

L-Configuration

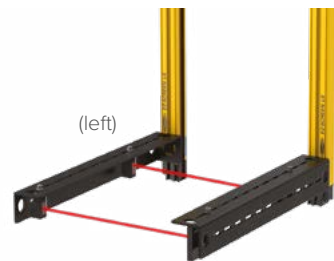

SGSA-ML-L-LPQ20

Includes 2 mute arms, 2 SGSA-Q20PLPQ5 mute sensors, and 2 retroreflectors

T-Configuration



SGSA-MT-LPQ20

Includes 4 mute arms, 4 SGSA-Q20PLPQ5 mute sensors, and 4 retroreflectors

X-Configuration

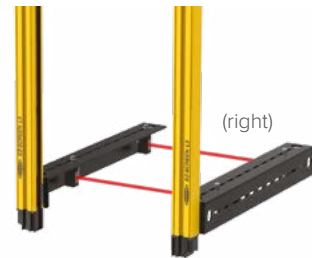

SGSA-ML-R-LPQ20

Includes 2 mute arms, 2 SGSA-Q20PLPQ5 mute sensors, and 2 retroreflectors



SGSA-MX-LPQ20

Includes 4 mute arms, 2 SGSA-Q20PLPQ5 mute sensors, and 2 retroreflectors



Integral muting models have muting technology built into the device eliminating the need for an external muting controller. Preassembled muting arm kits are available in T, L and X configurations. The muting kits use premounted hardware and Q20 retroreflective sensors and reflectors.

Benefits of Muting

- Maintain high safety standards while allowing for a predetermined object to break a beam
- Limit downtime by not unnecessarily shutting down a conveyor or robot cell

Applications

- Assembly and packaging machines
- Automated production equipment
- Robotic work cells
- Automated warehouses
- Palletizers

Mute Connection Options

Description	Models
Connection box for X, L or T mute arm kits	SGSA-MCB
Connection cable for X and L mute arm kits	SGSA-MCS-2
Connection cable for T mute arm kits	SGSA-MCS-4
Optional hardware kit for mounting mute connection box, or mute connection cable to the t-slot of SGS Receiver or Active Unit	SGSA-MCB-HW

Stands and Corner Mirrors



SGSA-S Series Enclosures

Fits SGS Models	# of Windows	Enclosure Height	Distance from Floor to Bottom Window	Distance between Beams	Enclosure Models
SGS..4-300Q..	4	1543 mm (60.75")	300 mm (11.8")	300 mm (11.8")	SGSA4-S300 SGSA4-S300-M
SGS..3-400Q..	3	1238 mm (48.78")	300 mm (11.8")	400 mm (15.8")	SGSA3-S400 SGSA3-S400-M
SGS..4-400Q..	4	1618 mm (63.69")	300 mm (11.8")	400 mm (15.8")	SGSA4-S400 SGSA4-S400-M
SGS..2-500Q..	2	1035 mm (40.75")	400 mm (15.8")	500 mm (19.7")	SGSA2-S500 SGSA2-S500-M



SSM Series Corner Mirrors

Fits SGS Models	Reflective Area	Mounting Area	Mirror Height	Mirror Models
SGS..2-500..	550 mm (21.7")	661 mm (26.0")	628 mm (24.7")	SSM-550
SGS..3-400..	825 mm (32.5")	936 mm (36.9")	903 mm (35.6")	SSM-825
SGS..4-300..	975 mm (38.4")	1086 mm (42.8")	1053 mm (41.5")	SSM-975
SGS..4-400..	1275 mm (50.2")	1386 mm (54.6")	1353 mm (53.3")	SSM-1275



MSA Series Stands

Pole Height	Usable Stand Height	Stand Models
1676 mm (66")	1550 mm (61")	MSA-S66-1
2134 mm (84")	2007 mm (79")	MSA-A84-1
2667 mm (105")	2667 mm (100")	MSA-S105-1

Cables



8-Pin M12 with Flying Leads

QDE-815D
4.5 m (15')
QDE-825D
7.6 m (25')
QDE-850D
15.2 m (50')



12-Pin M12 with Flying Leads

QDE-1215E
4.5 m (15')
QDE-1225E
7.6 m (25')
QDE-1250E
15.2 m (50')

Brackets



SA-MBK-10-4
End-mount bracket

Choosing a Banner Safety Scanner

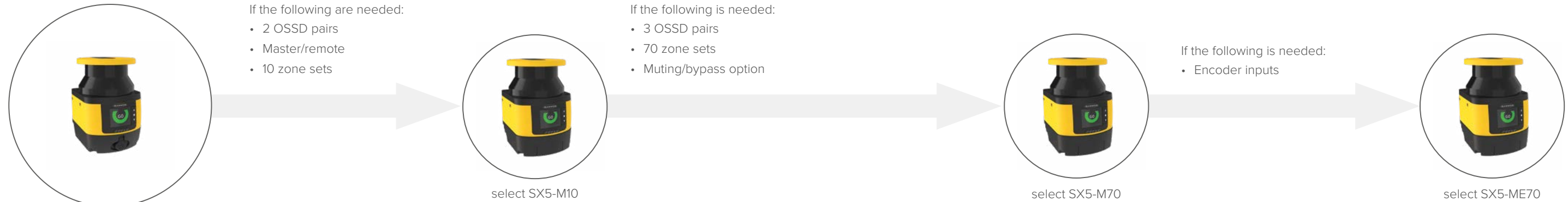

- Start with the SX5-B6
- 275° field of view
 - 5.5 meter range
 - Integral muting



SX5-B6



SX5-M10



SX5-M70



SX5-ME70



SX5-R

	SX5-B6	SX5-M10
Description	Stand Alone	Master
OSSD Pairs	1	2
Removable Memory		✓
Replaceable Window	✓	✓
Zone Sets	6	10

	SX5-M70	SX5-ME70	SX5-R
Description	Master	Master	Remote
OSSD Pairs	3	3	
Removable Memory	✓	✓	✓
Replaceable Window	✓	✓	✓
Zone Sets	70	70	Master

Safety Scanner Selection Guide



SX5-B6



SX5-M10

	p. 36	p. 36
Dimensions W x D x H (mm)	102 x 112 x 152	102 x 112 x 152
Presence Detection	50/70 mm	50/70 mm
Body Detection	70/150 mm	70/150 mm
Hand Detection	30/40 mm	30/40 mm
Range (depending on resolution)	30 mm = 2.5 m 40 mm = 3 m 50 mm = 4 m 70/150 mm = 5.5 m	30 mm = 2.5 m 40 mm = 3 m 50 mm = 4 m 70/150 mm = 5.5 m
Max. Zone Sets (depending on configuration)	6	10
Master Remote		Master (up to 3 remotes)
Removable Memory		SXA-RM-10
Speed Monitoring		
Max. OSSD Outputs (depending on configuration)	1x 2 OSSD	2x 2 OSSD
Inter Device Connection		8-Pin M12
Integral Muting	✓	✓
Programmable Dust Filter	✓	✓
Measurement Data	✓	✓
Field-replaceable Window	✓	✓



SX5-M70



SX5-ME70



SX5-R

	p. 36	p. 36	p. 36
Dimensions W x D x H (mm)	102 x 112 x 152	102 x 112 x 152	102 x 112 x 152
Presence Detection	50/70 mm	50/70 mm	50/70 mm
Body Detection	70/150 mm	70/150 mm	70/150 mm
Hand Detection	30/40 mm	30/40 mm	30/40 mm
Range (depending on resolution)	30 mm = 2.5 m 40 mm = 3 m 50 mm = 4 m 70/150 mm = 5.5 m	30 mm = 2.5 m 40 mm = 3 m 50 mm = 4 m 70/150 mm = 5.5 m	30 mm = 2.5 m 40 mm = 3 m 50 mm = 4 m 70/150 mm = 5.5 m
Max. Zone Sets (depending on configuration)	70	70	depending on master
Master Remote	Master (up to 3 remotes)	Master (up to 3 remotes)	Remote
Removable Memory	SXA-RM-70	SXA-RM-70	
Speed Monitoring		✓	
Max. OSSD Outputs (depending on configuration)	3x 2 OSSD	3x 2 OSSD	
Inter Device Connection	8-Pin M12	8-Pin M12	8-Pin M12
Integral Muting	✓	✓	✓
Programmable Dust Filter	✓	✓	✓
Measurement Data	✓	✓	✓
Field-replaceable Window	✓	✓	✓

Safety Scanner System

Horizontal or vertical monitoring of both personnel and stationary or mobile systems

SX Series safety laser scanners protect personnel, equipment, and mobile systems by continuously scanning a user-defined area of up to 275° to create a two-dimensional protected zone.

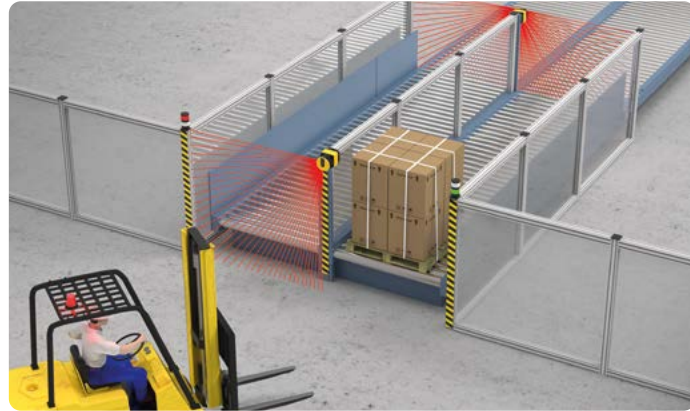

SX5 software configuration allows zone switching for full, right-side and left-side safety protection during this forklift access application.



Software interface makes it easy to create custom safety and warning zones to safeguard large, complex, and irregularly shaped areas.

Increased Machine Uptime

The SX5 has on-board LED indicators and a large multi-segment color display that provide at-a-glance system status information so users can quickly identify zone breaches and resolve issues with a minimal amount of equipment downtime.

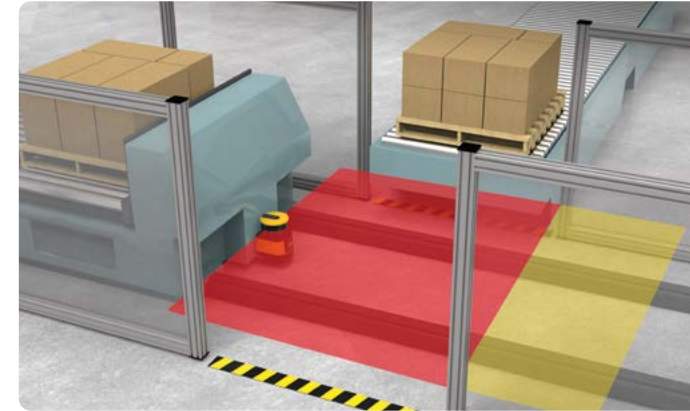

Compact, one-piece safety device installs easily above and away from area hazards without requiring time-consuming alterations to area infrastructure.

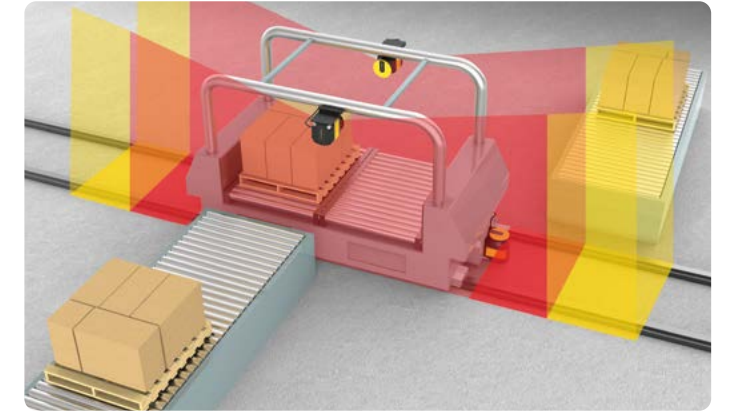

An alert is triggered if an object enters the warning zone and equipment will come to a stop if the safety zone is breached.

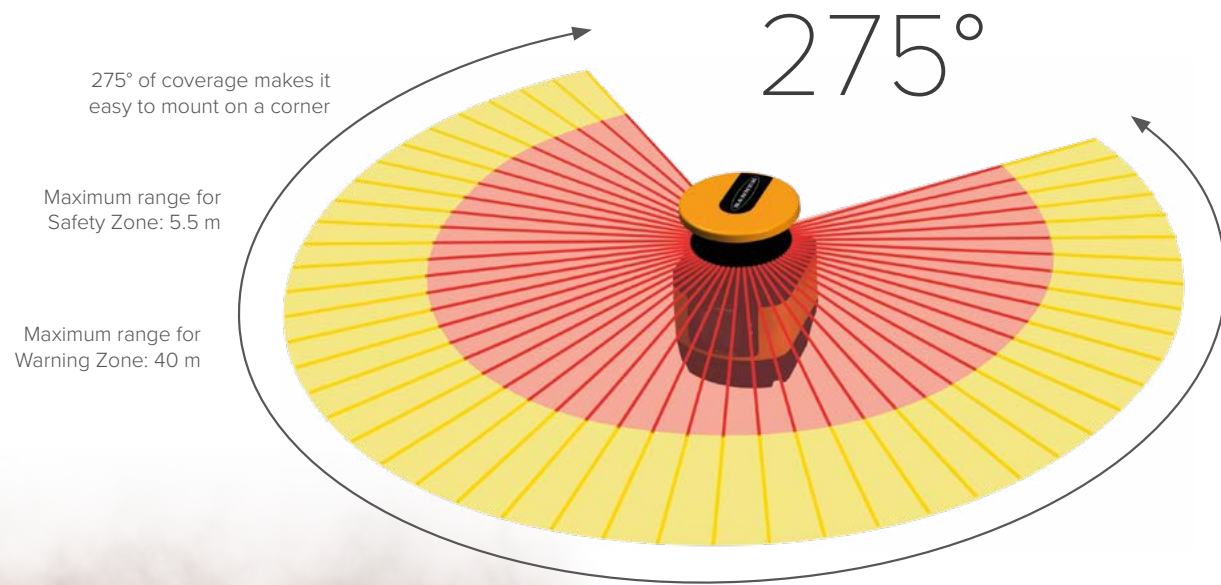

Light Immune and dust resistant – Best in class

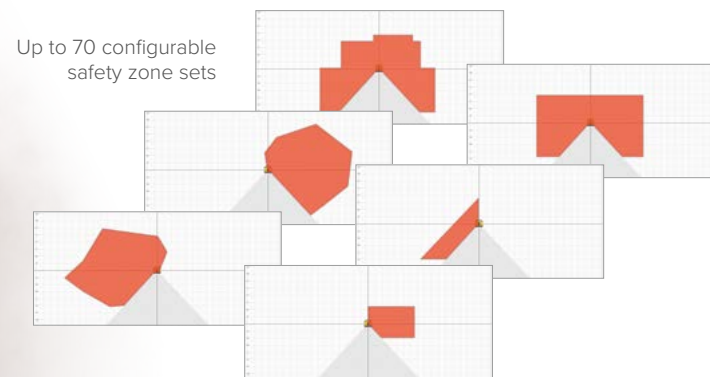

Up to 70 configurable safety zone sets



Rugged design for reliable industrial use

Numerous status, diagnostic, warning, and error displays

Dynamic Muting available and selectable detection capability for vertical applications



- LED 1: Object Detection in Safety Zone (OSSD)
- LED 2: Not Available
- LED 3: Assigned to Warning Zone 2
- LED 4: Assigned to Warning Zone 1
- LED 5: Interlock Status (waiting for Reset)



Keypad

M12 Ethernet connector cover for standalone models

Safety Scanner System

Removable memory for fast scanner replacement

The system configuration is backed up in a removable memory unit. Install your replacement scanner fast and easy, without needing to reconfigure your system. The machine interface cables attach to this memory unit on the Master models.



Master and Remote connection reduces wiring

For applications that require monitoring multiple sides of an AGV, up to four scanners can be easily connected through an Ethernet-based safe communications bus, working as a single system.

Each remote unit is connected to the master by a single cable that provides them with power, and the memory of the entire system is stored in the master.

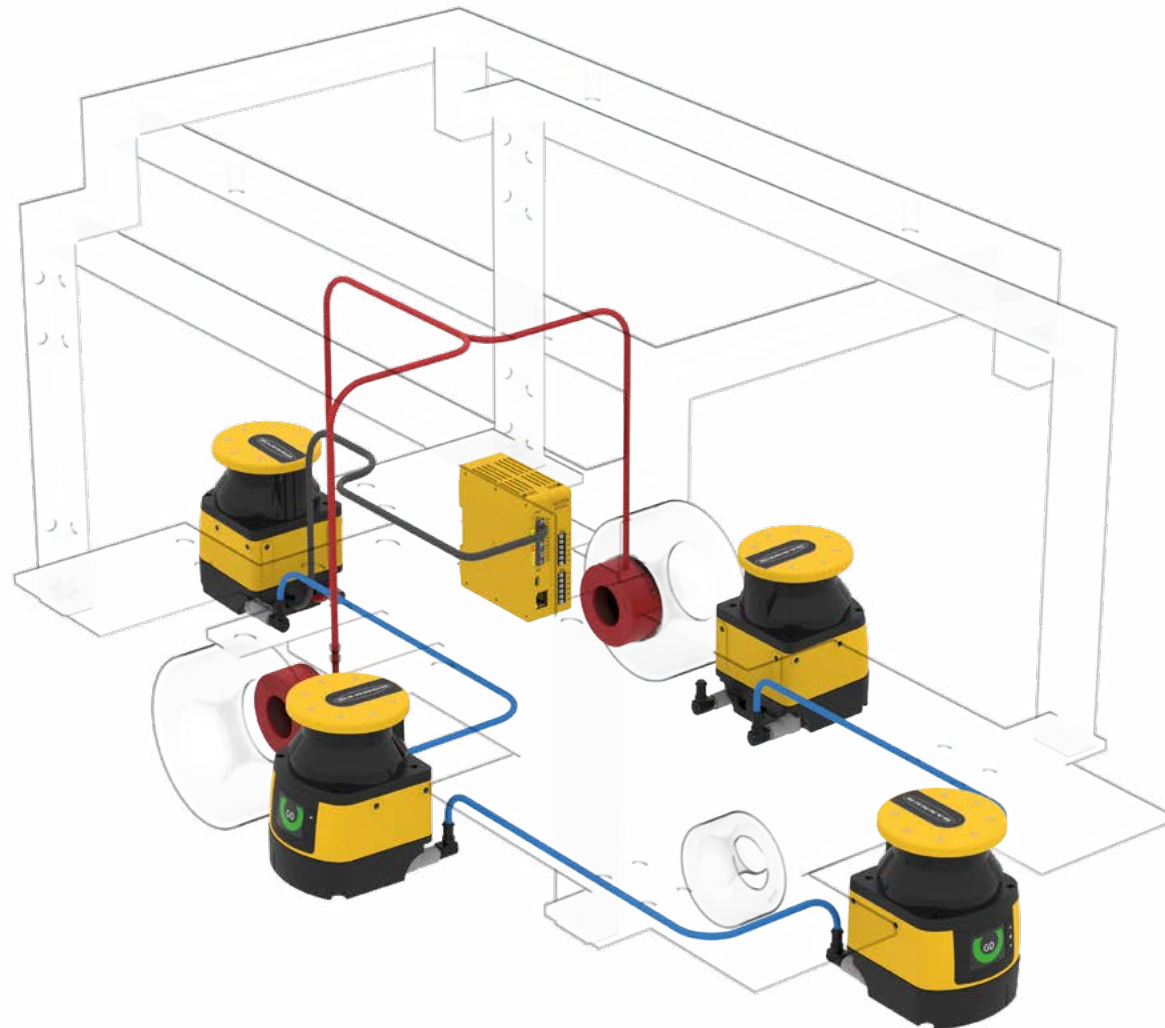
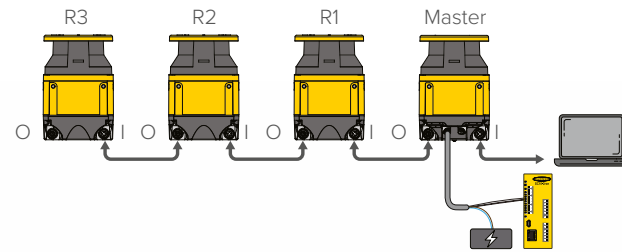

Safety Scanner Software

Simple setup for rapid deployment

The SX5 can be set up in just a few simple steps using Banner's free configuration software. This robust software features menu-driven tools that guide users through setup and make it easy to design custom safety and warning zones to accommodate existing infrastructure and meet the specific needs of any application.

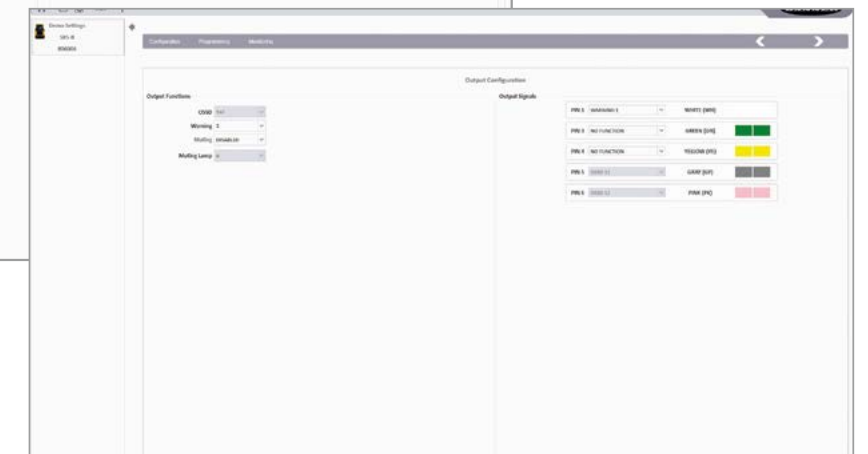
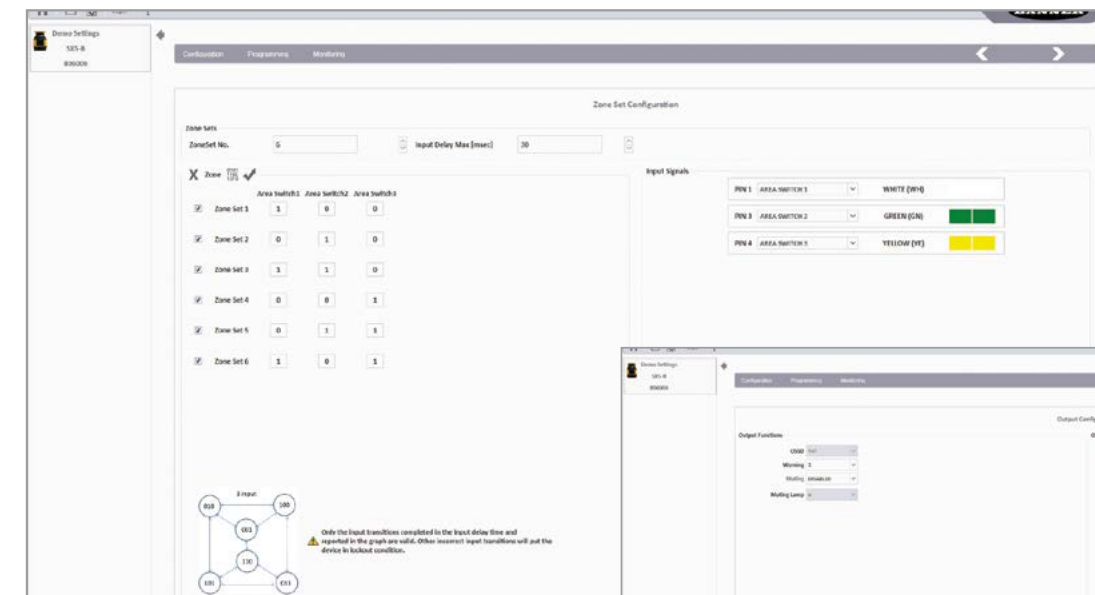
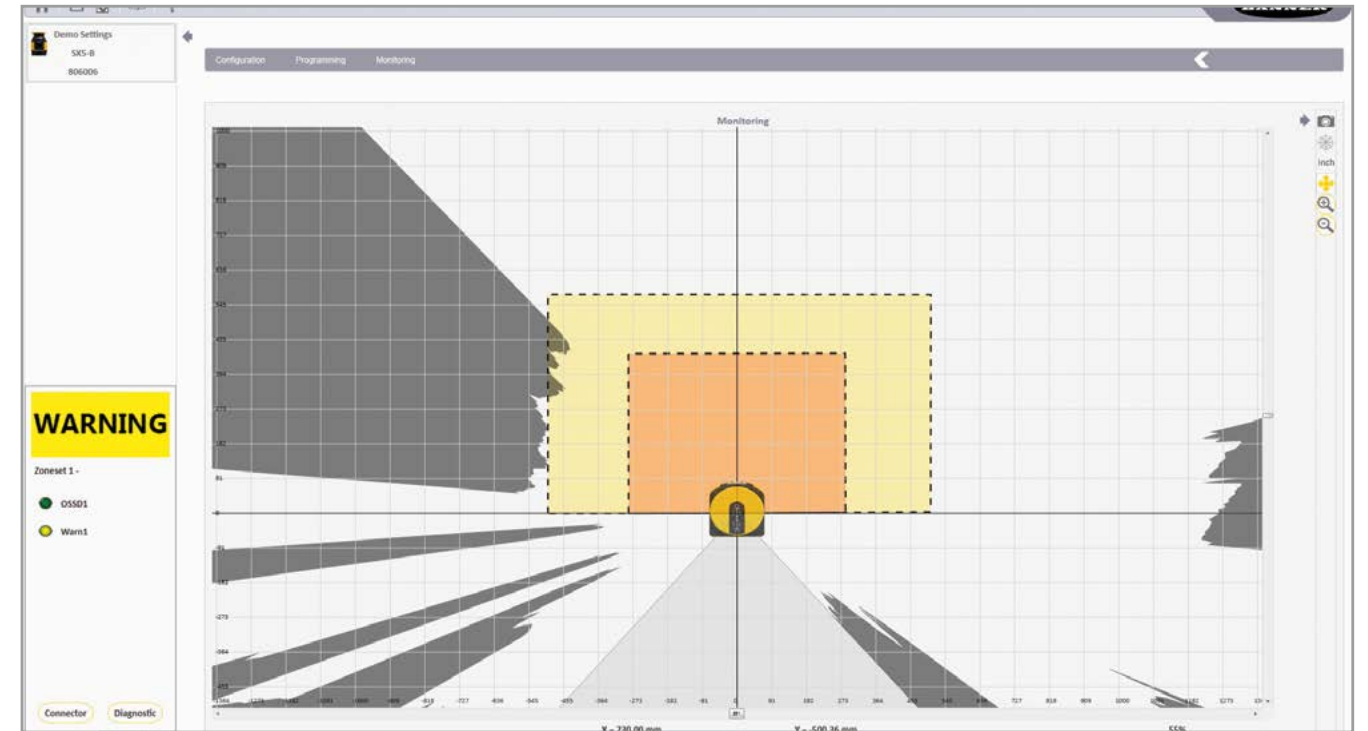

The software displays a graphic rendering of the monitored area and provides configuration and management tools, such as drop-down menus, function-specific worksheets, and more.

Safety Scanner Fixed Applications

Stationary area guarding

Stationary area guarding uses sensing fields such as safety or warning zones to continually sense an individual within a safeguarded area. Stationary area guarding can reduce or eliminate the possibility of a pass-through hazard that could result in an individual being exposed to unexpected machine startup or motion.

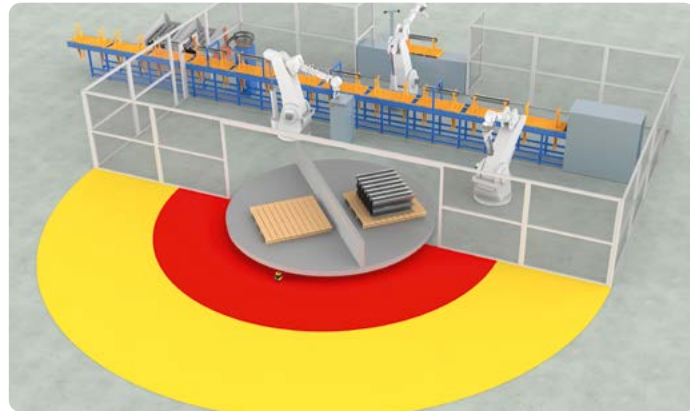

Single-zone safeguarding

The safety scanner detects when a person approaches a hazard. When the person enters a warning zone, the hazardous motion is controlled safely. When the person enters the safety zone, the hazard is stopped.



Multi-zone safeguarding

Up to three safety zones can be monitored simultaneously and independently. This way, safety in the entire plant is optimized, ensuring increased productivity and improved ergonomics in the entire plant.



Multi-zone safeguarding via master-remote

Manage multiple areas with master-remote architecture. Multiple safety zones stop different parts of the dangerous machine, without the need of an external controller.

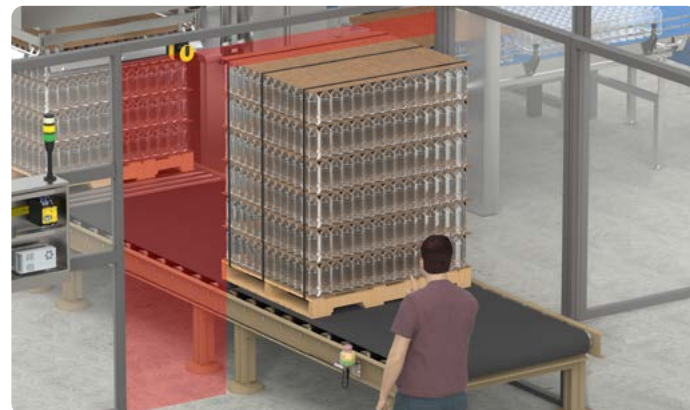

Safeguarding with dynamic and partial muting

Muting sensors can be directly connected to the SX5, creating a tightly protected area around the muted object while muting is active. Each safety output can be configured with its own muting requirements.

Safety Scanner Mobile Applications

Mobile area guarding

On mobile applications, the SX5 monitors the area directly ahead of the vehicle using both the warning and the safety zones. The vehicle slows down if something is detected in the warning zone and the vehicle stops when something is detected in the safety zone. If the speed increases or decreases, alternate zone sets can be used to adjust for varying stopping distances.

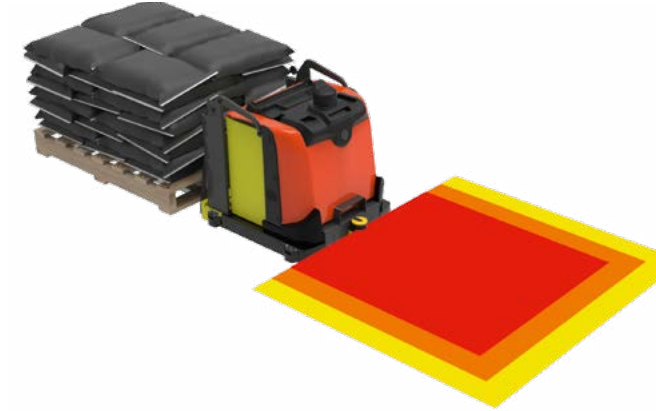

Automated guided vehicle collision avoidance

Warning and safety zones can be used to alert operators, slow down the vehicle, or stop it. Up to 70 different zones can be set and activated per position, speed and movement of the vehicle.



Safe speed monitoring

Incremental encoders inputs can be directly read by the SX5 scanner in order to select the appropriate slow-down and stopping areas, based on the speed of the vehicle.

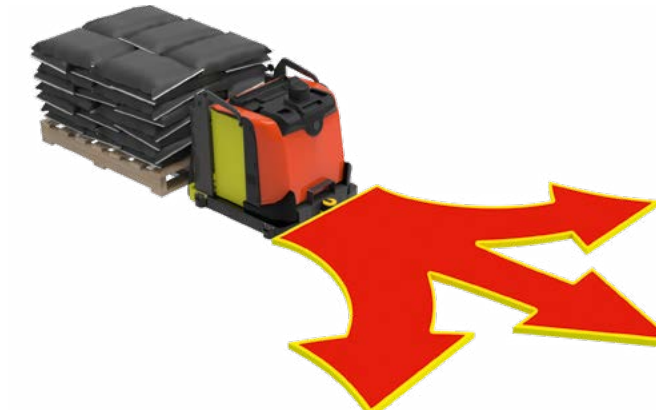

Advanced measurement data for direct navigation

The SX5 has a direct transmission protocol over Ethernet. It can be used to read measurement data for vehicle navigation. Data includes active zone, I/O status, measured speed, intensity of beams, and diagnostic.

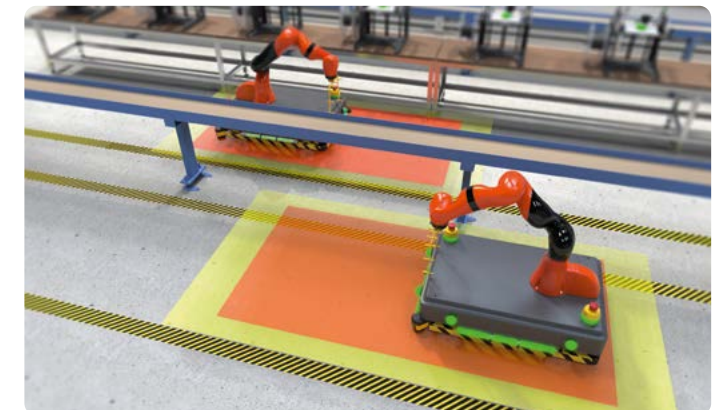

Collaborative robot monitoring

Mobile collaborative robots (cobots) have built-in safety features that enable them to work alongside humans. Cobots can be programmed to slow down or stop when a human enters the warning or safety zone.

Choosing a Banner Relay and Controller



Start with the SC10

- PC configured logic
- 10 safe inputs
- 2 independent safe outputs
- In-Series Diagnostics
- Ethernet/IP, Profinet, Modbus TCP

- If the following are needed:
- More than 10 safe inputs
 - More than 2 safe outputs



select SC26

- If the following are needed:
- Pre-configured logic
 - One safe input
 - One safe output



select Safety Relays

If the following is needed:

- Up to 138 safe inputs
- Up to 68 safe outputs
- EtherCAT
- In-Series Diagnostics



select XS26



SC10



Safety Relay

Configurable Logic	✓	
Safe Inputs	10	1
Safe Outputs	2	1
ISD (In-Series Diagnostics)	✓	
	✓	

EtherCAT



SC26



XS26

✓	✓
26	Up to 154
2	Up to 64
	✓
✓	✓
	✓

Relay and Controller Selection Guide



GM/ES p. 46 UM p. 46 SM p. 46 AT p. 46 MMD p. 46

	Preconfigured Safety Relay Modules				
Device Type	Preconfigured Safety Relay Modules				
Self Testing Safety Device		✓			✓
Self Testing Safety Device with EDM Function		✓			✓
E-Stop	✓	✓			✓ (secondary function)
Rope Pull	✓	✓			✓ (secondary function)
Gate Switch (potential free contacts)	✓	✓			✓
RFID Gate Switch (OSSD contacts)		✓			✓
ISD Functionality					
Safety Mat Monitoring			✓		
Two-Hand Control				✓	
Enabling Device	✓	✓			
Expandable					
Muting					✓
ON/OFF Delay					
Speed Monitoring					
Safety Standard	Cat. 4 PL e, per EN ISO 13849-1; SIL 3 per IEC 61508 and IEC 62061				
Inputs	1 NC and 1 NO (single or dual) 1 NC (single) 2 NC (dual)	1 NC (single) or 2 NC (dual) or 2 PNP	1 (or multiple in series) 4-wire safety mat	2 STB or buttons with complementary contacts	2 NC mutable (dual) and 2 NC SSI (dual)
Safety Outputs	2 NO, 3 NO, 4 NO	2 NO or 3 NO	4 NO	2 NO	2 PNP OSSD or 2 NO
Maximum Safety Output Rating	6A, 7A	7A	6A	6A	6A
Auxiliary Outputs	1 NC or 1 NC and 2 PNP	1 NC, depending on model	1 NC and 2 PNP		1 PNP or 1 NC
Power Supply	24 V AC/DC 115 V AC and 12-24 V DC or 230 V AC and 12-24 V DC	24 V AC/DC	115 V AC and 12-24 V DC or 230 V AC and 12-24 V DC	24 V AC/DC	24 V DC



SSM p. 46 SR p. 46 IM p. 46 EM p. 46

	Preconfigured Safety Relay Modules			
Device Type	Preconfigured Safety Relay Modules			
Self Testing Safety Device				
Self Testing Safety Device with EDM Function		✓	✓	
E-Stop				
Rope Pull				
Gate Switch (potential free contacts)				
RFID Gate Switch (OSSD contacts)				
ISD Functionality				
Safety Mat Monitoring				
Two-Hand Control				
Enabling Device				
Expandable				✓
Muting				
ON/OFF Delay				OFF delay available
Speed Monitoring	✓			
Safety Standard	Cat. 4 PL e, per EN ISO 13849-1; SIL 3 per IEC 61508 and IEC 62061			
Inputs	2 PNP	2 NC (dual) or 2 PNP	2 NC (dual) or 2 PNP	1 NC (single) or 2 NC (dual)
Safety Outputs	2 NO	2 NO, 3 NO	2 NO, 3 NO	4 NO or 4 NO with delay
Maximum Safety Output Rating	4A	6A	6A	6A
Auxiliary Outputs	1 NC	1 NC	1 NC, depending on model	
Power Supply	24 V DC	24 V DC	24 V DC	24 V DC or 24 V AC/DC, depending on model



SC10 p. 48 SC26/XS26 p. 48

	Configurable Controllers	
Device Type	Configurable Controllers	
Self Testing Safety Device	✓	✓
Self Testing Safety Device with EDM Function	✓	✓
E-Stop	✓	✓
Rope Pull	✓	✓
Gate Switch (potential free contacts)	✓	✓
RFID Gate Switch (OSSD contacts)	✓	✓
ISD Functionality	2 chains	8 chains
	✓	✓
		✓
Safety Mat Monitoring	✓	✓
Two-Hand Control	✓	✓
Enabling Device	✓	✓
Expandable		✓
Muting	✓	✓
ON/OFF Delay	✓	✓
Speed Monitoring		
Safety Standard	Cat. 4 PL e, per EN ISO 13849-1; SIL 3 per IEC 61508 and IEC 62061	
Inputs	10	SC26: up to 26 XS26: up to 154
Safety Outputs	2x 3 NO	SC: 2 XS: up to 68
Maximum Safety Output Rating	6A each	0.5A each
Auxiliary Outputs	depends on configuration	depends on configuration
Power Supply	24 V DC	24 V DC

Safety Relays and Controllers



Industrial safety controllers and relays provide an interface between safety devices and the machines and processes those devices monitor for a complete and easy-to-use safety control solution.



Safety controllers can be tailored for a wide variety of machines, including machines with multiple processes.

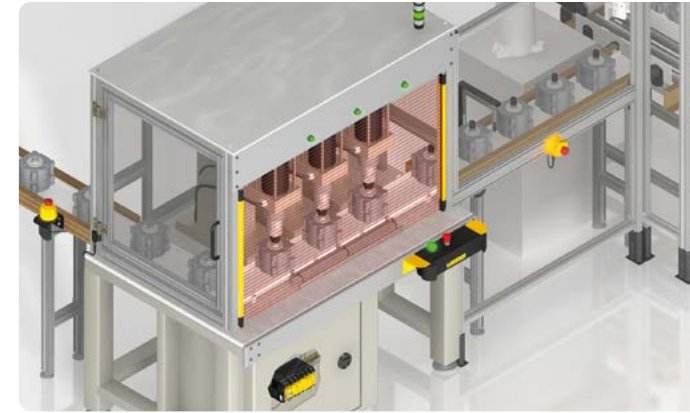

Configurable controllers monitor multiple safety devices, such as E-stop buttons, safety switches, safety light screens, two-hand controls, and rope pull switches.

Safety Relays



Cost-effective for simple safety circuits

- Preset functionality: Configuration not required
- Safety inputs: 1
- Independently controlled safety outputs: 1; 4 to 7A
- Choose from a variety of models:
 - Universal input safety relays
 - E-stop monitoring safety relays
 - Muting safety relays
 - Safe speed monitoring relays
 - Safety mat relays
 - Safety extension relays
 - Interface relays

Hybrid Safety Controller Plus 2 Safety Relays



Flexible and cost-effective solution for machines typically using 2 safety relays

- PC configurable: Flexible and easy-to-use
- Safety inputs: up to 10; up to 70 with ISD
- Independently controlled safety outputs: 2; 6A each
- Convertible safety inputs: 4
- Terminal LEDs for easy troubleshooting
- Industrial Ethernet
- Each output contains 3 NO redundant safety contacts

Expandable Safety Controller



Expandable for complex safety applications where 3 or more safety relays are typically used

- PC configurable: flexible and easy-to-use
- Safety inputs: 26 (base unit) up to 154
- Independently controlled safety outputs: up to 68; 0.5A to 6A each
- Convertible safety inputs: 8 (Base Unit) up to 40
- LCD screen for easy troubleshooting
- Industrial Ethernet



Connect safety devices easily to the safety controller



Safety Controllers

XS26 Expandable Safety Controller

26 to 154 Safety Inputs



Safety Outputs
Safety Zones: 2 to 64
• 6A Relay 2 NO
• 0.5A Solid State

Industrial Ethernet
EtherNet/IP Modbus TCP/IP EtherCAT

- Optional display screen allows local diagnostics for efficient troubleshooting
- Up to eight expansion I/O modules can be added as automation requirements grow or change
- Choose from six expansion module models with a variety of safety inputs, solid-state safety outputs and safety relay outputs
- Controller and input modules allow safety inputs to be converted to status outputs for efficient terminal use

SC10 Safety Controller

10 Safety Inputs

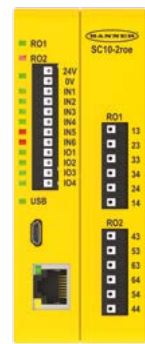

Safety Outputs
Safety Zone 1: 6A Relay 3 NO
Safety Zone 2: 6A Relay 3 NO

Industrial Ethernet
EtherNet/IP Modbus TCP/IP EtherCAT

- 10 safety inputs
- 4 safety inputs allowed to be converted to status outputs for efficient terminal use
- 2 redundant safety outputs
- LED indication next to each output
- Industrial Ethernet two-way communication
- Programmable via USB connection
- In-Series Diagnostic capable

Easy to Configure and Integrate with a PLC

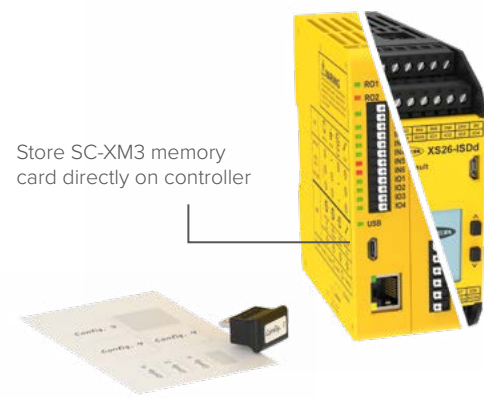

- SC-XM3 Fast Programming and Swapout
- Backup copy of configuration, password, network settings
 - Download configuration without a PC
 - Save time during panel build
 - Fast swapout minimizes downtime

- Free Software
- Intuitive PLC Integration

In-Series Diagnostics Functionality

In-Series Diagnostics allows you to connect up to 32 devices with one in-series connection and communicate directly with the most commonly used PLCs. Achieves up to CAT4, SIL3, PLe safety rating.

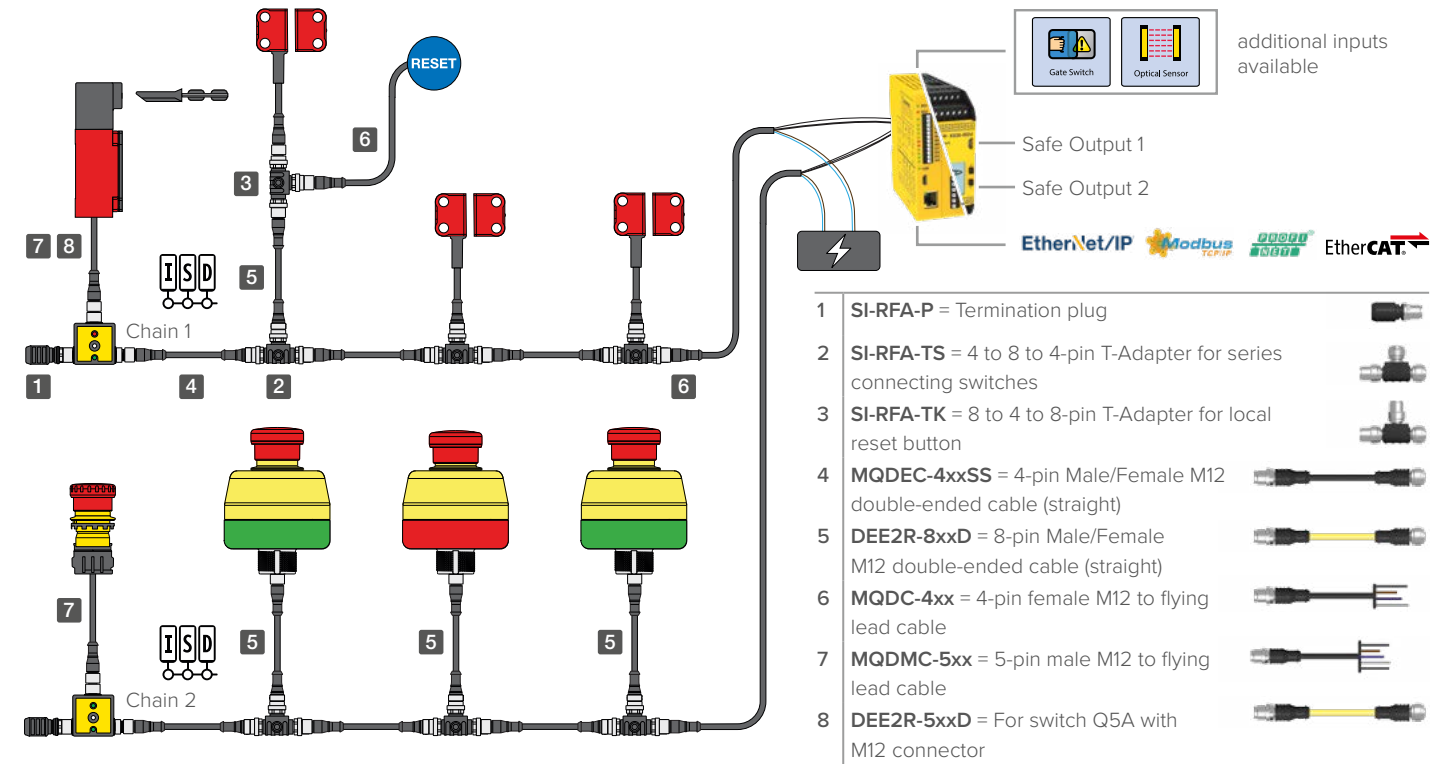

Compatible Devices

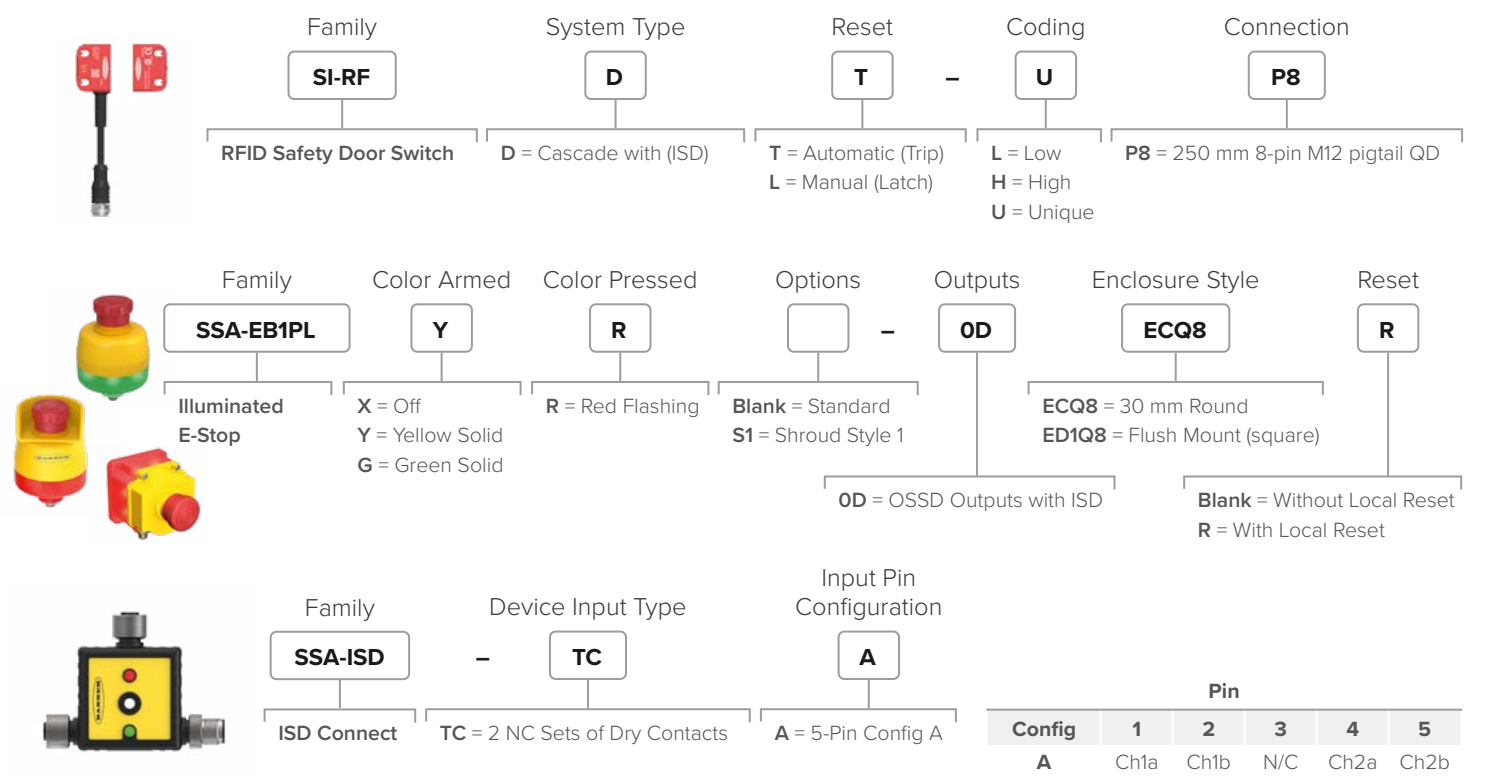

Configure Your System in Minutes

The feature-rich SC10 and SC/XS26 safety controller software provides a seamless user interface for setting up and managing safety systems. The software features an intuitive icon-based, drag-and-drop user interface to reduce the learning curve and speed up commissioning.

- Complex configurations made easy
- Simulate configurations before implementation
- Auto configure Industrial Ethernet for remote monitoring and diagnostics

Start using the **free software** today. Go to www.bannerengineering.com/safetycontroller

1. Choose Controller



2. Equipment View

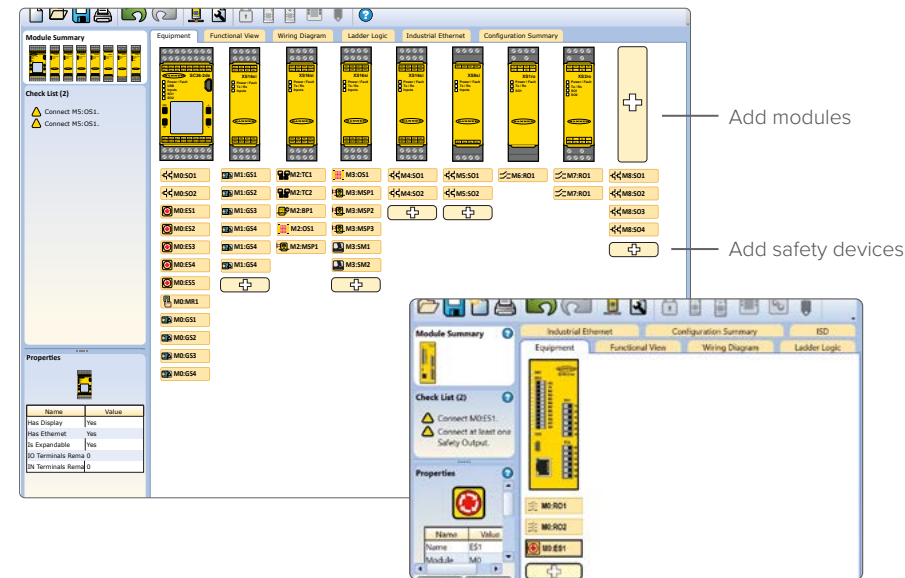

3. Add safety devices

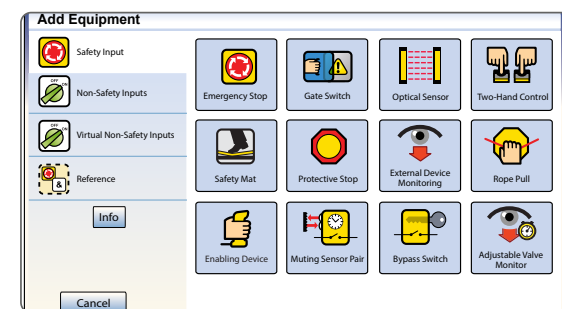

4. Select safety device properties

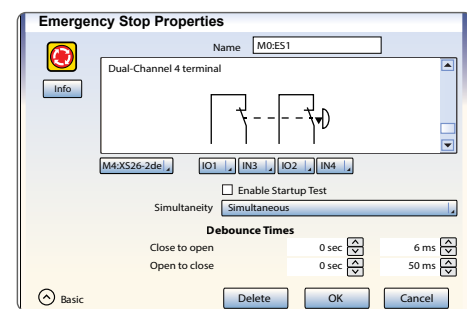

5. Add virtual non-safety inputs

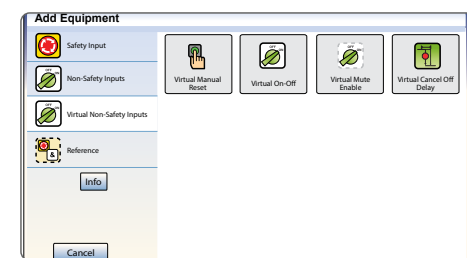

Intuitive setup and PLC integration

- Expedite PLC Integration with Tag Export Feature
- Eliminates error-prone manual entries
- Import tags to PLC via .csv or .xml files
- Defines actionable In-Series Diagnostic data within the PLC
- For more information visit bannerengineering.com/safetycontroller

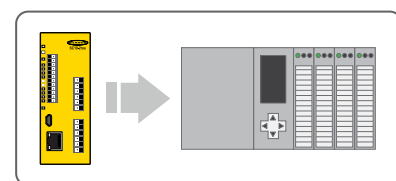

System Software

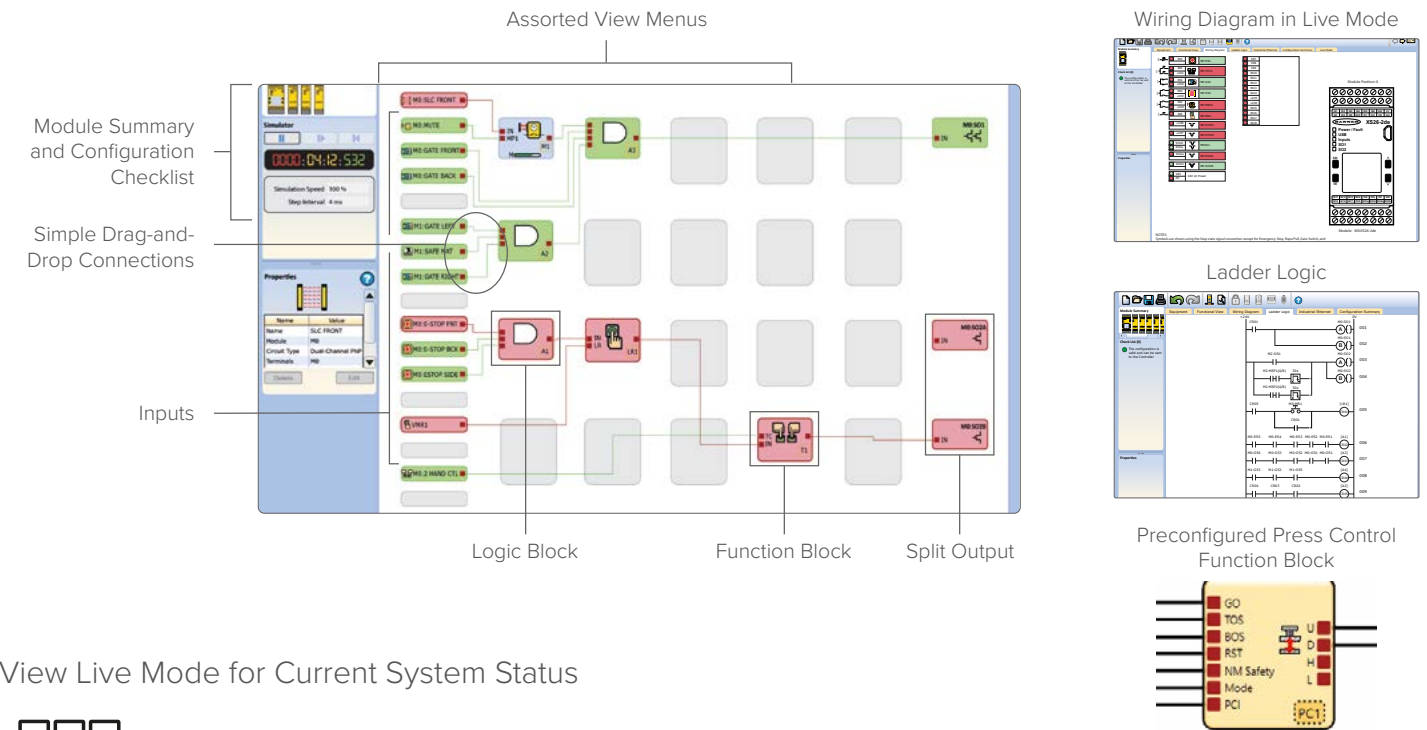

View Live Mode for Current System Status

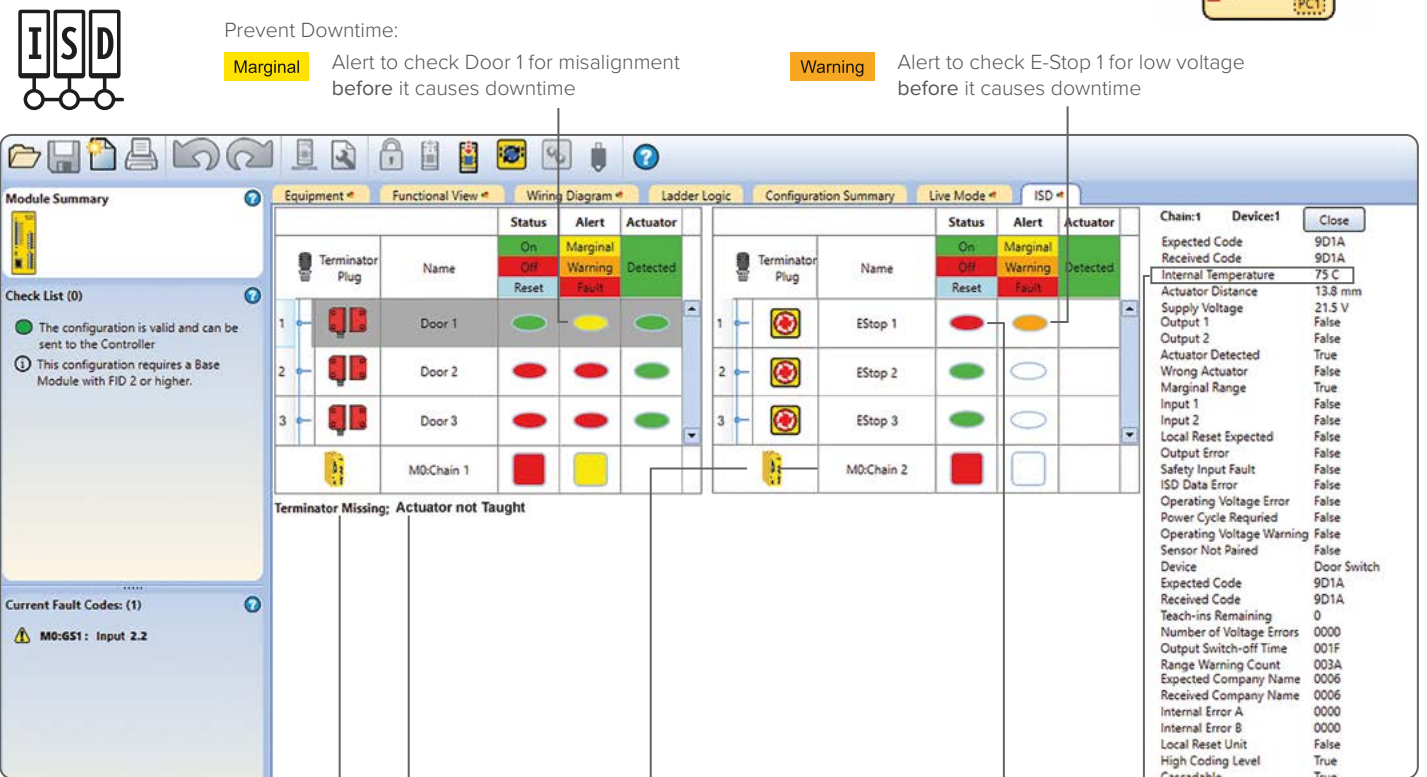

Troubleshooting Made Easy:

Terminator missing

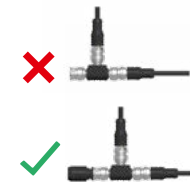

Actuator not taught



Up to 32 ISD safety devices in any order per chain

Reduce Downtime: Local operator guidance to activated E-Stop



Additional uses for ISD

- Rotation/Indexing
- Tool Identification
- Position Verification

Safety Relays

E-Stop and Guard Safety Modules

Supply Voltage	Inputs	Safety Outputs	Aux. Outputs	Output Rating	Output Response Time	Models
24 V AC/DC	1 NC & 1 NO (single or dual)	2 NO	–	6 A	35 ms	GM-FA-10J
	1 NC (single) or 2 NC (dual)	3 NO	–	6 A	25 ms	ES-FA-9AA
	1 NC (single) or 2 NC (dual)	2 NO	1 NC	7 A	25 ms	ES-FA-11AA
	1 NC (single)	3 NO	1 NC	6 A	35 ms	ES-FA-6G
115 V AC & 12-24 V DC	1 NC (single) or 2 NC (dual)	4 NO	1 NC & 2 PNP	6 A	25 ms	ES-UA-5A
230 V AC & 12-24 V DC						ES-VA-5A

Universal Safety Input Modules

Supply Voltage	Inputs	Safety Outputs	Aux. Outputs	Output Rating	Output Response Time	Models
24 V AC/DC	1 NC (single) or 2 NC (dual) or 2 PNP	3 NO	–	6 A	25 ms	UM-FA-9A
		2 NO	1 NC	7 A		UM-FA-11A

Modules for Specific Monitoring Applications

Supply Voltage	Inputs	Safety Outputs	Aux. Outputs	Output Rating	Output Response Time	Models
115 V AC & 12-24 V DC	1 (or multiple in series) 4-wire safety mat	4 NO	1 NC & 2 PNP	6 A	50 ms	SM-GA-5A
230 V AC & 12-24 V DC						SM-HA-5A
24 V AC/DC	1 (2x2 complementary) for two-hand control	2 NO	–	–	35 ms	AT-FM-10K

Muting Modules

Supply Voltage	Input Device	Inputs	Safety Outputs	Aux. Outputs	Output Rating	Output Response Time	Models
24 V DC	Electromechanical & solid state	2 NC muteable (dual) & 2 NC SSI (dual)	2 PNP OSSD	1 PNP	0.5 A	10 ms	MMD-TA-12B
			2 NO	1 NC	6 A	20 ms	MMD-TA-11B

Safe Speed Monitoring Modules

Supply Voltage	Inputs	Safety Outputs	Aux. Outputs	Output Rating	Ranges (impulses/minute)	Models
24 V AC/DC	2 PNP	2 NO	1 NC	4 A	5-40, 35-340, 300-2700, 1200-10500	SSM-FM-11A10
					10-80, 80-650, 600-5300, 2400-20000	SSM-FM-11A20

Interface Modules

Supply Voltage	Inputs	Safety Outputs	Aux. Outputs	Output Rating	Output Response Time	Models
24 V DC	2 NC	3 NO	–	6 A	20 ms	SR-IM-9A
		2 NO	1 NC			SR-IM-11A
		3 NO	–			IM-T-9A
		2 NO	1 NC			IM-T-11A

Safety Controllers

Non-expandable Safety Controllers

Description	Housing H x W x D (mm)	Inputs/Convertible	Independently Controlled Safe Outputs	Maximum Safety Output Rating	Features	Models (24 V DC)
SC26 Safety Controller	110 x 45 x 128	26/8	2 Dual Channel PNP	0.5A at 24 V DC	Display	SC26-2d
					Display, Ethernet	SC26-2de
					–	SC26-2
SC10 Safety Controller	115 x 45 x 100	10/4	2 Dual Channel Relays	2x 3 NO: 6A 250 V AC/24 V DC	Ethernet	SC26-2e
					ISD, Ethernet	SC10-2roe

Expandable Safety Controllers

Description	Housing H x W x D (mm)	Inputs/Convertible	Independently Controlled Safe Outputs	Maximum Safety Output Rating	Features	Models (24 V DC)
XS26 Expandable Safety Controller	110 x 45 x 128	26/8	2 Dual Channel PNP	0.5A at 24 V DC	Display	XS26-2d
					Display, Ethernet	XS26-2de
					–	XS26-2
					Ethernet	XS26-2e
Safety Input Module	W: 22.5 mm	8/2	–	–	–	XS26-ISDd
		16/4	–	–	–	XS8si
Safety Output Module	W: 22.5 mm	–	2 Dual Channel PNP	0.75A at 24 V DC	–	XS16si
		–	4 Dual Channel PNP	0.5A at 24 V DC	–	XS2so
Safety Relay Output Module	W: 22.5 mm	–	1 Dual Channel Relay	6A; 2 NO, 1 NC Aux (2.5A)	–	XS4so
		–	2 Dual Channel Relays	6A; 2x 2 NO, 2x 1 NC Aux (2.5A)	–	XS1ro
Network Expansion Module	W: 22.5 mm	–	–	–	Ethercat	XS2ro
						XSeCAT

Expansion Modules

Supply Voltage	Inputs	Safety Outputs	Output Rating	Aux. Outputs	Output Response Time	Delay	Models
24 V DC	1 NC (single) or 2 NC (dual)	4 NO	6 A	–	20 ms	–	EM-T-7A
				–	35 ms	–	EM-F-7G
24 V AC/DC	1 NC (single)	4 NO w/delay	6 A	–	–	0.5 s	EM-FD-7G2
				–	–	1.0 s	EM-FD-7G3
				–	–	2.0 s	EM-FD-7G4

Accessories



SC-USB2
USB Cable



SC-XM2
Memory Card for XS26 and SC26



SC-XM3
Memory Card for SC10



SC-XMP2
SC-XM2/3 Configuration Tool

Choosing a Banner Safety Switch



Start with the SI-MAGB

- Non-contact safety switch
- 3 to 5 mm misalignment tolerance
- IP67 Rated
- Single sensor at SIL3, Ple, Cat 4

If the following are needed:

- Locking



select SI-GL42

If the following are needed:

- ISD
- Daisy Chain at SIL3, PLE Cat4
- 10 mm misalignment tolerance
- IP69 rated



select SI-RF

If the following are needed:

- Position detection



select SI-LS83

If the following are needed:

- Mechanical latch
- Hinge function



select SI-HG63 or Mechanical



SI-MAGB Mag Switch



SI-GL42 Locking Switch



SI-RF RFID Switch



SI-LS83 Limit Switch



SI-HG63 Hinge Switch



Mechanical Switches

	SI-MAGB Mag Switch	SI-GL42 Locking Switch	SI-RF RFID Switch
Safety Rating (single sensor)	Ple, CAT4	Ple, CAT3*	Ple, CAT4
Environmental Rating	IP67	IP67	IP69
ISD (In-Series Diagnostics)		ISD Connect Ready	✓
Tamper Resistance - Coding Level	Low	Low	Low, High, Unique
Assured On Sao / Misalignment Tolerance (mm)	3 to 5		10

	SI-LS83 Limit Switch	SI-HG63 Hinge Switch	Mechanical Switches
Safety Rating (single sensor)	Ple, CAT3*	Ple, CAT3*	Ple, CAT3*
Environmental Rating	IP65	Up to IP69	IP65
ISD (In-Series Diagnostics)		ISD Connect Ready	ISD Connect Ready
Tamper Resistance - Coding Level	Low	Low	Low
Assured On Sao / Misalignment Tolerance (mm)			

*Ple/Cat 4 achieved with applicable second safety switch added

Safety Switches Selection Guide



SI-MAG

p. 58



SI-RF

p. 60



SI-LS

p. 58



SI-QS

p. 58



SI-LM40

p. 58



SI-GL42

p. 58



SI-LS42

p. 58



SI-LS83

p. 58



SI-HG63

p. 58



SI-HG80

p. 58

	SI-MAG	SI-RF	SI-LS	SI-QS	SI-LM40	SI-GL42	SI-LS42	SI-LS83	SI-HG63	SI-HG80
Device Type	Magnetic	RFID	Lockable		Lockable				Hinge	
Switch Style	Non-Contact	Non-Contact	Separate Actuator	Separate Actuator	Separate Actuator	Separate Actuator	Separate Actuator	Limit	Hinge	Hinge
Non-Locking	✓	✓	✓	✓	✓			✓	✓	✓
Locking						✓	✓			
Position	✓	✓								Plunger, Roller, Spindle-mount, Lever
Contacts	1 NC, 1 NO	OSSD PNP	2 NC, 1 NO 1 NC, 1 NO 2 NC	1 NC, 1 NO 2 NC 2 NC, 1 NO 1 NC	1 NC, 1 NO 2 NC 2 NC, 1 NO	1 NO 1 NC 1 NC, 1 NO 2 NC 2 NC, 1 NO 3 NC	1 NC, 1 NO 2 NC, 1 NO 1 NC 2 NC 3 NC	1 NC, 1 NO 2 NC	2 NC, 1 NO	SPDT
Locking or Unlocking Power						24 V AC/DC	24 V AC/DC 110 V AC/230 V AC			
Straight Rigid Inline			✓		✓	✓	✓			
Rigid Inline			✓	✓		✓				
Flexible Inline			✓	✓	✓	✓	✓			
High-Force Accessory				✓						
LED Status Indication		✓								
Cascadable		✓								
ISD (In-Series Diagnostics)		✓								
Coding level/ Manipulation protection EN ISO 14119	Low coding	Unique/Low/High coding	Low coding	Low coding	Low coding	Low coding	Low coding	Uncoded	Uncoded	Uncoded
Housing Material	Plastic	Plastic	Plastic	Plastic	Metal	Head: Metal Body: Plastic	Plastic	Plastic	Metal	Metal
Locking						Spring lock Solenoid lock	Spring lock Solenoid lock			
Actuation Extraction Force			10 N	10 N High-Force models: adjust. from 50-100 N	10 N, 20 N	1500 N when locked	2000 N when locked			

Safety Switches



The SI-GL42D fail-safe guard locking switch has several guard locking options: manual, spring-to-lock, or power-to-lock. The safety switch can manually be unlocked using a tool in case of maintenance work. Emergency or escape release are additional functions that allow for quick intervention when required. In spring-to-lock models, the guard is locked by spring force. To unlock, the solenoid must be energized. In power-to-lock models, the guard is locked when the solenoid is energized. To unlock, power must be switched off.

Hinge Switches



- One-piece sensor and actuator with hinge function
- Fast installation and setup with repositionable safety switch point
- Stainless steel and IP69 available
- Matching hinges without sensing available for additional door support
- Available with up to 270° safety switch point operation range

Non-Contact Switches



- Two-piece design where sensor and actuator do not contact
- Coded magnets/tags minimize the potential for intentional defeat
- A single pair can achieve up to Category 4/PL safety rating
- Accommodating to misalignment
- Non contact solution minimizes device wear and tear, even in applications with persistent use
- Up to IP69 solutions available

Mechanical Switches



- Two-piece design with mechanical operator feedback
- Flexible actuator options for misalignment
- Rotatable heads for flexible installation
- Mechanically coded actuator to minimize tampering
- Up to 15N latching force to reduce downtime due to vibrating doors
- One-piece limit switches available

Locking Switches



- Two-piece design with up to 2000N locking force for safety or process critical applications
- Flexible actuator options for misalignment
- Rotatable heads for flexible installation
- Mechanically coded actuator to minimize tampering
- Up to 15N latching force to position door prior to locking

Limit Switches



- Cost effective one piece sensor
- No actuator allows for fewer alignment issues
- Hideable making them more tamper resistant
- Rotating head and top or side engagement allows for eight different actuator positions
- Design meets positive opening requirements for safety switches

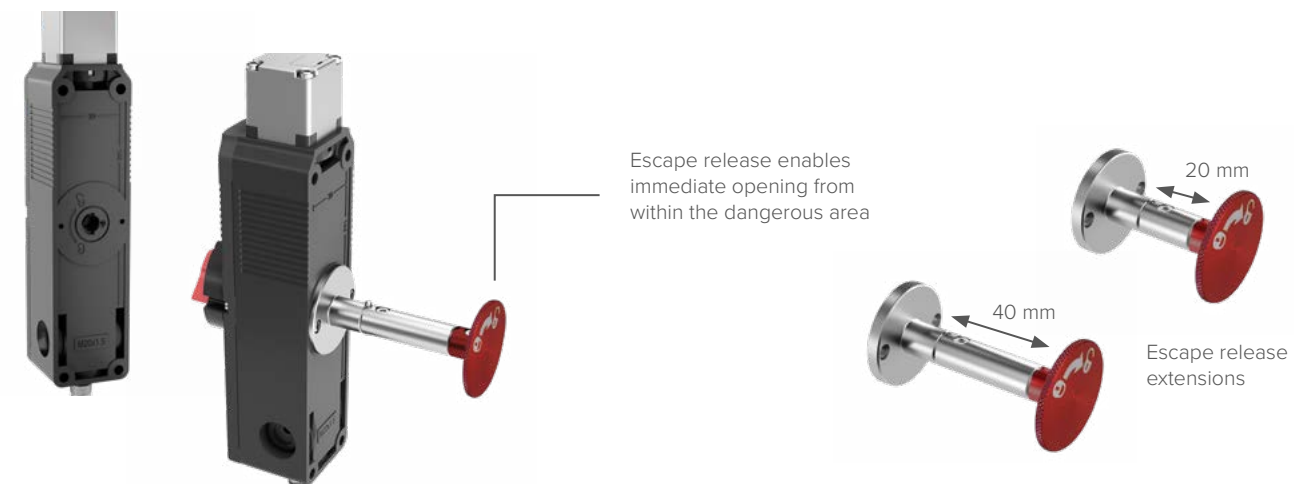

Non-Contact RFID Safety Switches



Safety switches respond when a mechanical guard is opened. They feature “positive opening” contacts for high reliability regardless of environmental conditions and withstand attempts to override the switch and defeat the system.

RFID SI-RF Switches



Single door RFID non-contact gate/door sensing solution

- Basic, medium, and high tamper resistance
- Misalignment tolerance of 10 mm
- Resistant to high vibration and operations with metallic shavings
- On-board LED for status and diagnostics

RFID SI-RF Switches – Cascade



Multiple door RFID non-contact gate/door sensing solution

- Basic, medium, and high tamper resistance
- Misalignment tolerance of 10 mm
- Resistant to high vibration and operations with metallic shavings
- On-board LED for status and diagnostics
- Connect up to 32 sensors in cascade while maintaining the highest level of safety
- 4-pin QD connections for cost-effective, simple, error-free installation
- RFID cascade with In-Series Diagnostics available



Enabling Devices

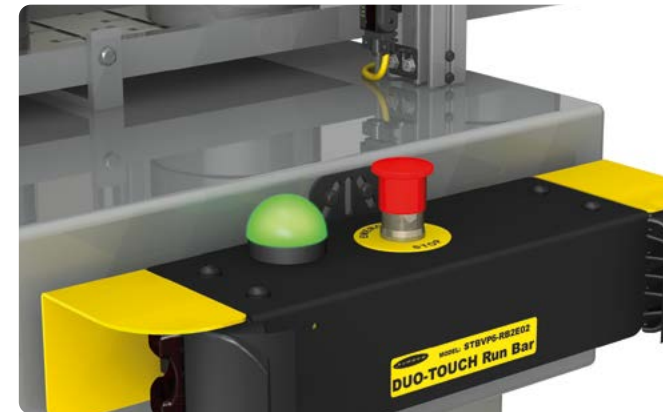

A two-hand control safeguarding system will prevent the operator from approaching the machine while a hazard is present. Duo-Touch Run Bar provides an all-in-one solution.

Handheld grip-styled switches are used for manual control of machine functions including visual observations, minor adjustments, calibration, and more.

Two-Hand Control

STB Self-Checking Touch Buttons

Connection	Touch Surface Material	Output	Power Supply	Models
2 m cable	Polyetherimide (PEI)	Solid-state 2 Complementary PNP (1 ON, 1 OFF)	10-30 V DC	STBVP6
4-pin M12 QD				STBVP6Q5
2 m cable		E/M Relay 2 Complementary SPST (1 NC, 1 NO)	20-30 V AC/DC	STBVR81
5-pin M12 QD				STBVR81Q6



STB buttons include yellow field cover to prevent unintended switching. To comply to safety standards, STB buttons must be used with appropriate Two-Hand control modules, SC26, XS26 or SC10 Safety Controller or comparable Type IIIC Two-Hand system.

DUO-TOUCH Two-Hand Control Kits with STB Touch Buttons
2 NO safety outputs, no auxiliary outputs, 24 V AC/DC, Cat 4 and Type IIIC

Module	IP Rating	STB Buttons (2 pieces)	IP Rating	Connection	Kits
AT-FM-10K	IP20	STBVP6	IP66	2 m cable	ATK-VP6
		STBVP6Q5		4-pin M12 QD	ATK-VP6Q5



Kit does not include run bar

Two-Hand Control Run Bars

Run Bars with STBVP6

Models	IP Rating	Models	IP Rating	Connection	E-Stop
STBVP6-RB1	IP20	STBVP6-RB2	IP65	Terminal strip	Not included
STBVP6-RB1Q8		STBVP6-RB2Q8		8-pin 7/8 QD	Not included
STBVP6-RB1E02		STBVP6-RB2E02		Terminal strip	SSA-EBM-02L



Enabling Devices

ED1G Enabling Devices

Contact Configuration	Momentary Push Button	Models
2 NO & 1 NC Aux	–	ED1G-L21SM-1N
2 NO & 1 NC Aux	1 NO	ED1G-L21SMB-1N
2 NO	2 NO	ED1G-L20MB-1N



Safety Switches

Magnetic Switches

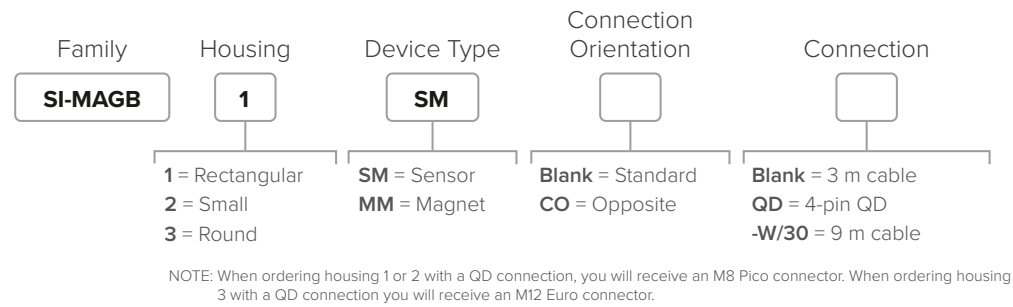

RFID Switches



SI-RF-A or SI-RF-A2 actuator is required to complete a sensor solution (ordered separately)

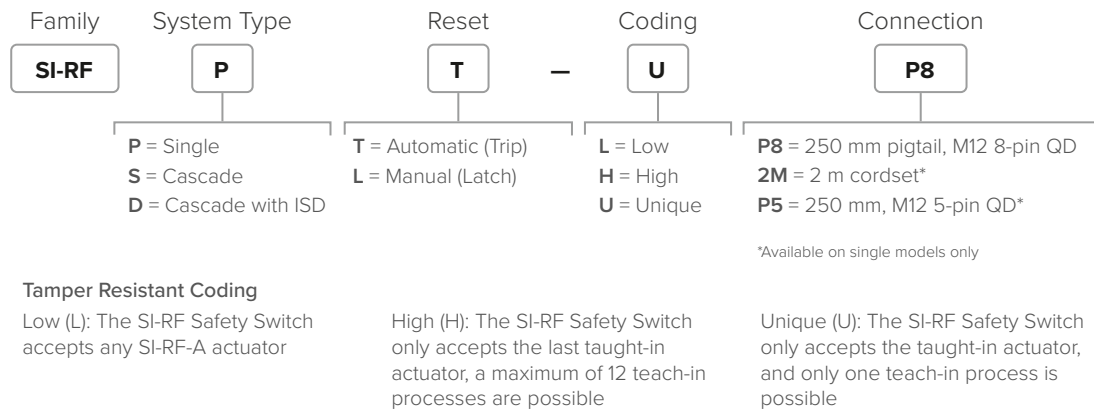

Hinge Switches

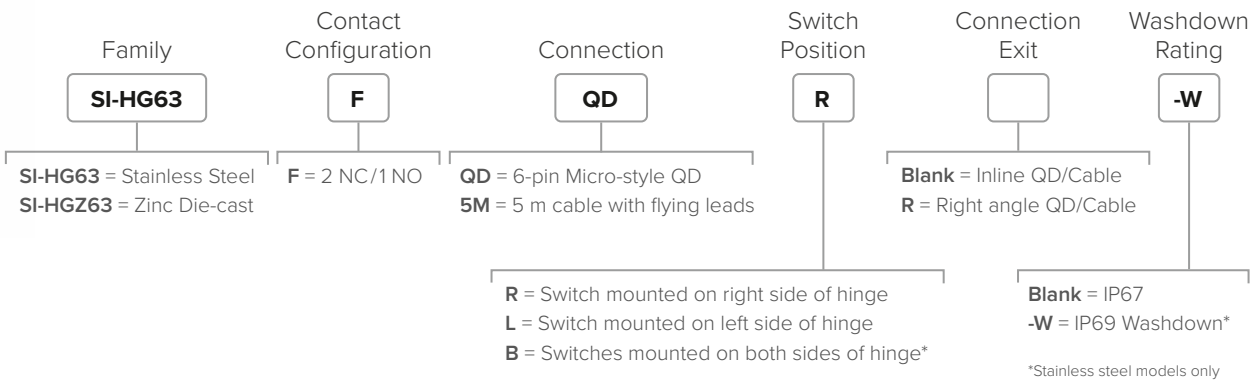

Brackets



SI-HG80DQD

Inline QD Fitting



SI-HG80DQDR

Right-angle QD Fitting



SI-HG80A

Blank Hinge



SI-HG63A

Blank Hinge

Adaptor Cable



MQEAC-601-Q5A

SI-HG63 to ISD Connect Adaptor Cable

Mechanical Switches

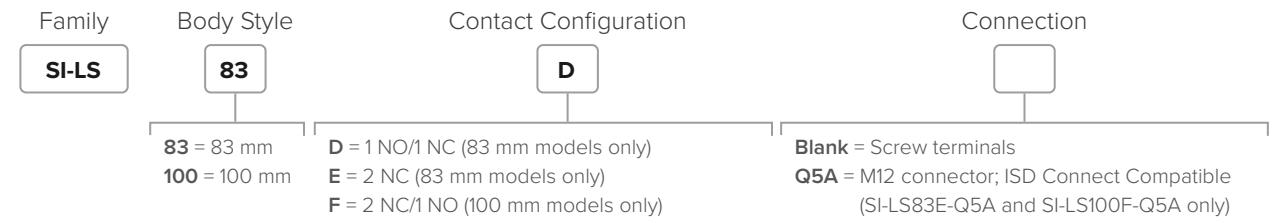

Actuators



SI-QS-SSA-2
Straight Rigid Inline Actuator



SI-QS-SSA-3
Right-Angle Rigid Inline Actuator



SI-QS-SSU
Flexible Inline Actuator

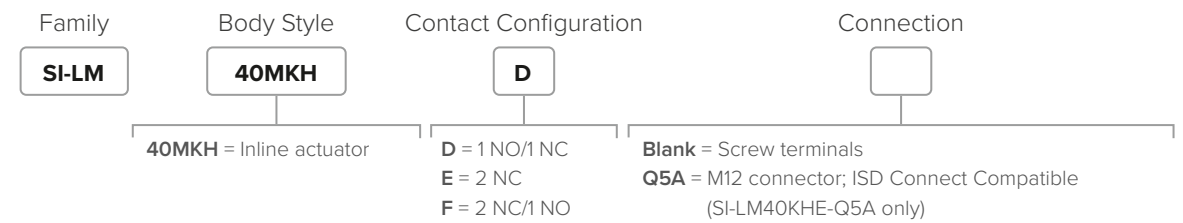

Actuators



SI-QM-SSA

Straight Rigid Inline Actuator



SI-QM-SMFA

Flexible Inline Actuator

Safety Switches

Locking Switches

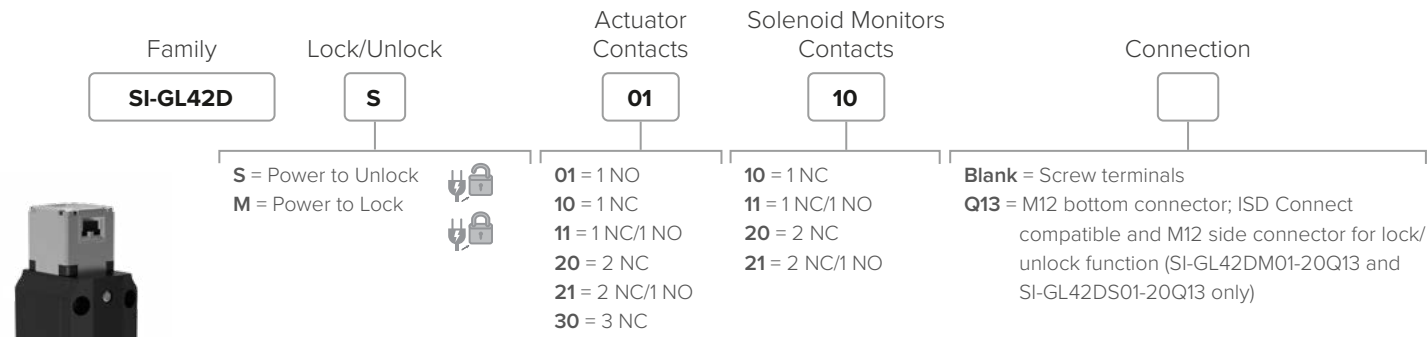

Actuators



Unlock Mechanism



Locking Switches

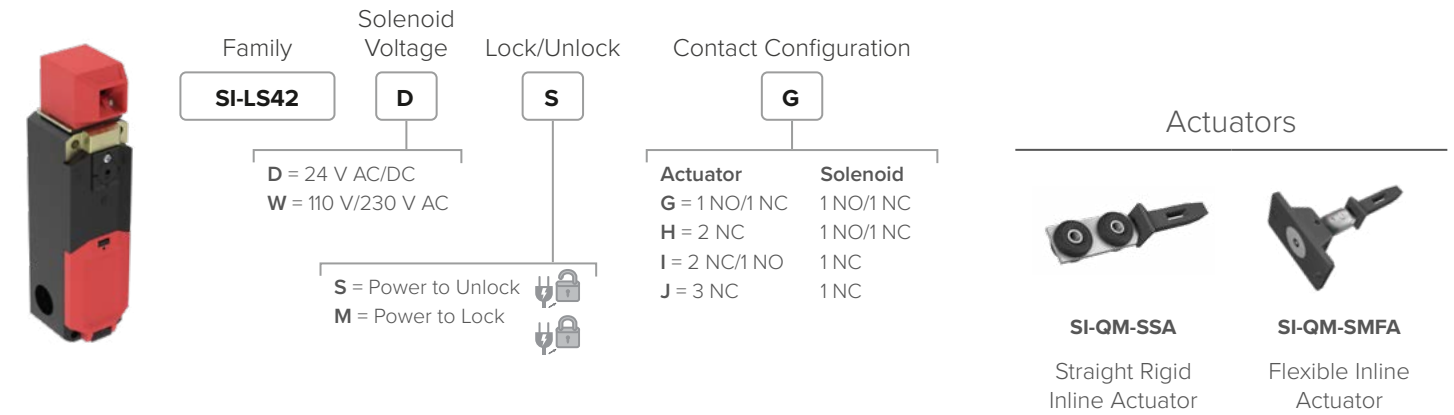

Limit Switches

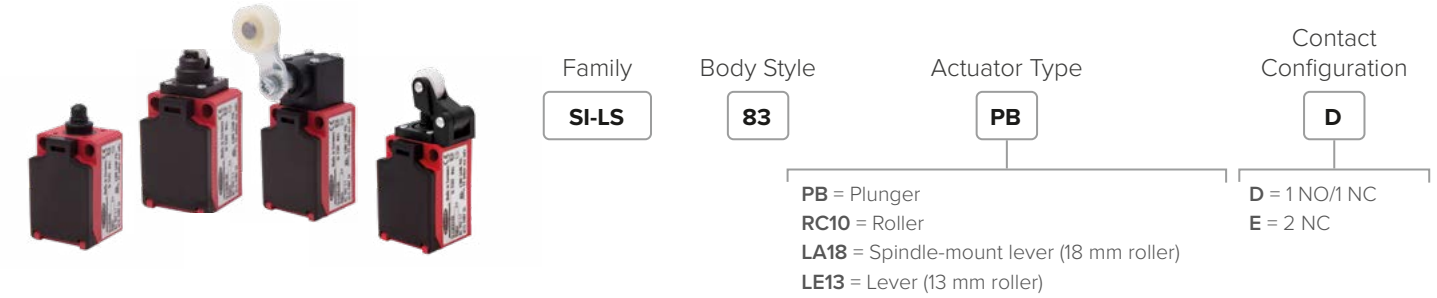

Choosing a Banner E-Stop Device

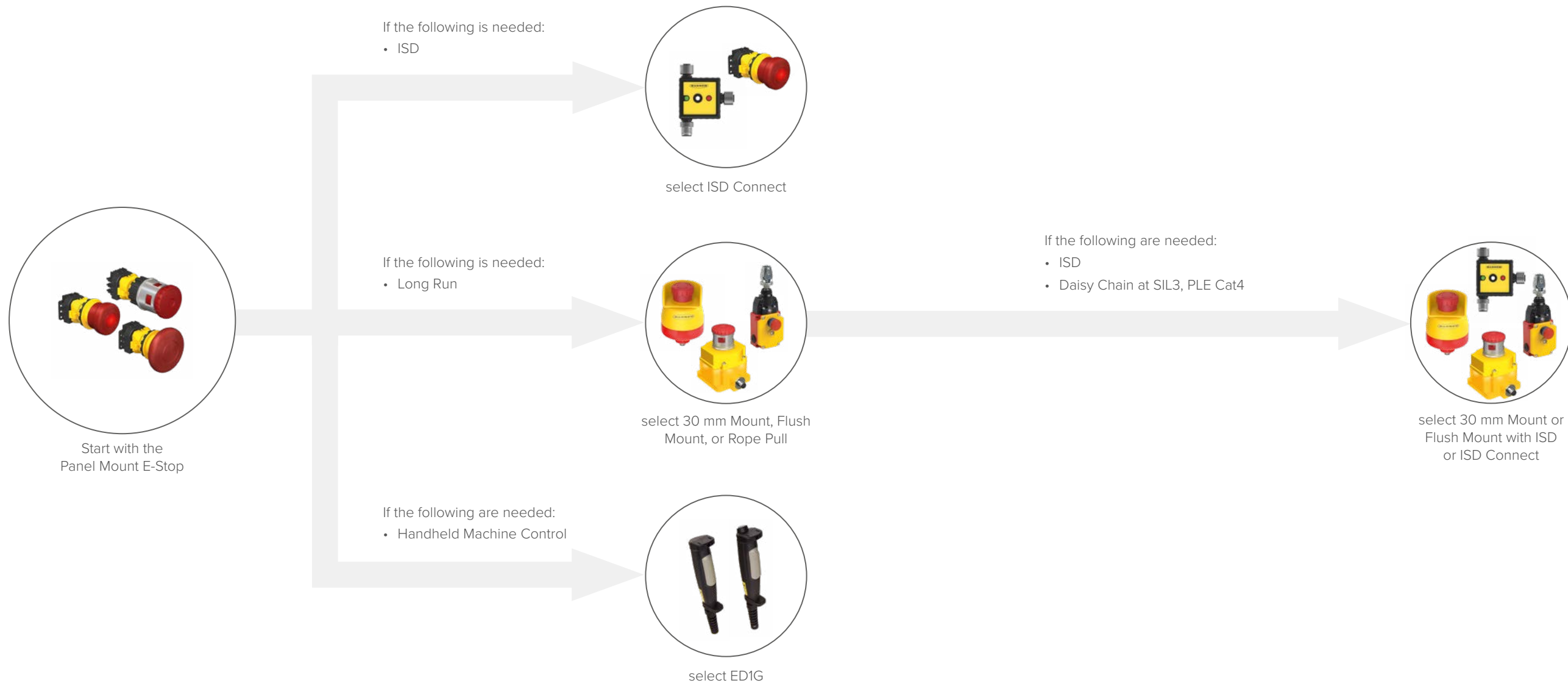

Panel Mounted E-Stop

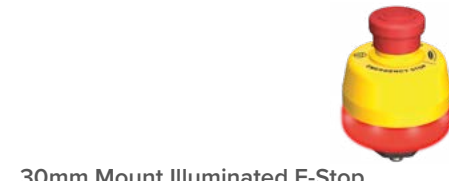

30mm Mount Illuminated E-Stop



Flush Mount Illuminated E-Stop



Rope Pull



ED1G Enabling Device

ISD (In-Series Diagnostics)	ISD Connect Ready	✓
Illumination	Button Option	Base 360 Degrees
Fully Assembled with M12 QD	Option	✓
Long Run (ie. conveyors)		✓ (daisy chain)
Shrouded & Lockable Option	✓	✓

✓	ISD Connect Ready	
Base 360 Degrees	K30 Option	
✓	Option	
✓ (daisy chain)	✓ (continuous)	
✓		

Handheld Manual Control

✓

E-Stop Devices Selection Guide



SSA-EBM p. 70
SSA-EB p. 70

Panel Mount Emergency Stop Buttons

E-Stop	✓	✓
Rope Pull		
Button Size (mm)	40 mm	40, 44, 60 mm
Illuminated Housing		
Illuminated Button		✓
Release	✓	✓
Lock/Unlock Button		✓ (SSA-EB1M only)
Rope Length (m)		
Rope Connection		
ISD (In-Series Diagnostics)		
Safety Contacts	1 NC 2 NC	1 NC 2 NC 3 NC 4 NC
Auxiliary Contacts	1 NO	1 NO 2 NO
OSSD Outputs		
Connection	Screw terminals	Screw terminals
Panel/Bracket Hole (mm)	22 mm	30 mm



SSA-EB1PL p. 70
SSA-EB1P p. 70
SSA-EB1M p. 70

Emergency Stop Buttons

✓	✓	✓
40, 60 mm	40, 60 mm	44 mm
✓		✓
✓	✓	
✓	✓	✓
		✓
✓	✓	
1 NC 2 NC 4 NC	1 NC 2 NC 4 NC	1 NC 2 NC 4 NC
1 NO 2 NO	1 NO 2 NO	1 NO 2 NO
✓	✓	
M12 or Screw terminals	M12 or Screw terminals	M12 or Screw terminals
30 mm	30 mm	



RP-RM83 p. 71
RP-LS42 p. 71
RP-QM(T)72 p. 71
RP-LM40 p. 71
RP-QM90 p. 71

Rope Pull Emergency Stop Switches

✓	✓			
✓	✓	✓ (only stop control)	✓ (only stop control)	✓
32 mm	32 mm			
✓				
38 m 70 m	25 m 37.2 m 75 m	6 m 12 m 20 m	6 m	50 + 50 m
Built-in turnbuckle or ring connection	Built-in turnbuckle or ring connection	Ring connection	Ring connection	Ring connection
2 NC	2 NC	2 NC 4 NC	2 NC	2 NC
2 NO	2 NO	1 NO (specific models)		2 NO
Screw terminals	Screw terminals	Screw terminals	Screw terminals	Screw terminals

E-Stop Devices

E-Stop Buttons*

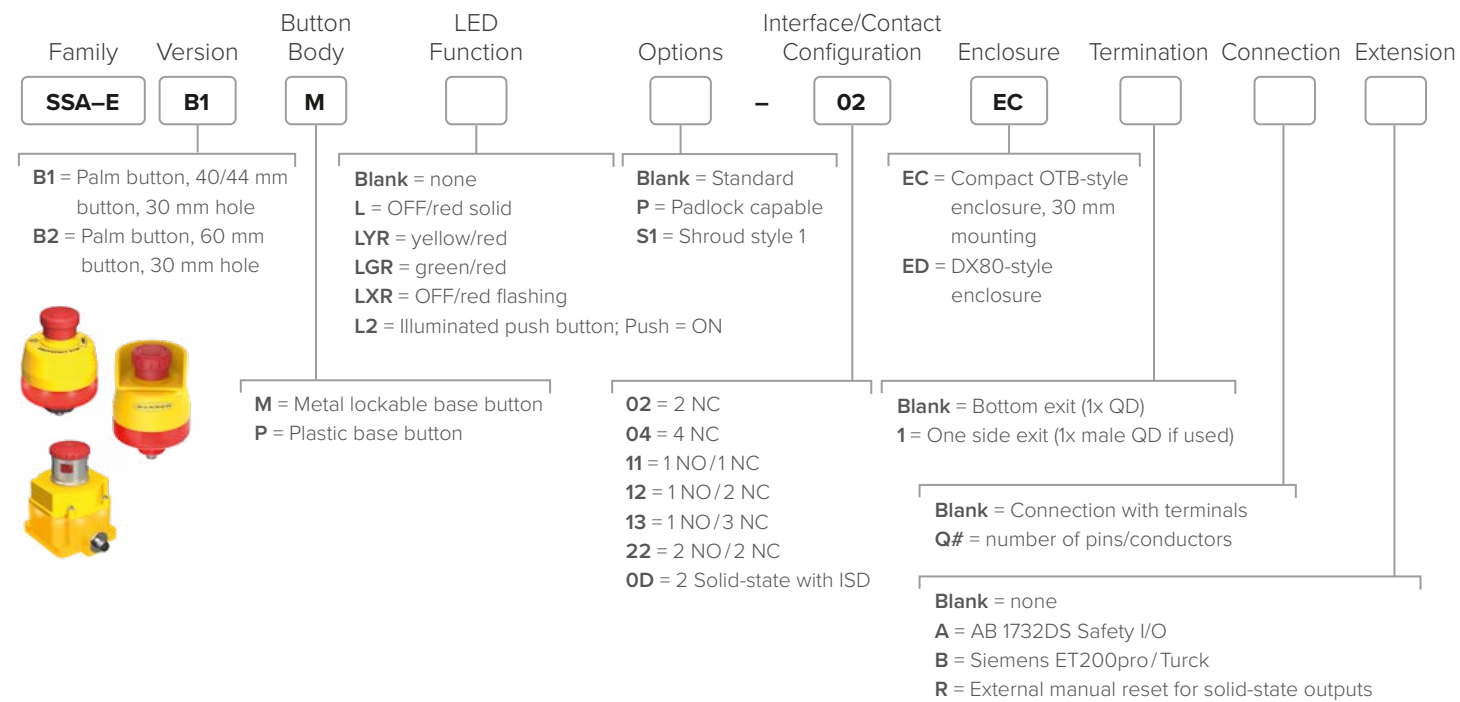

Accessories

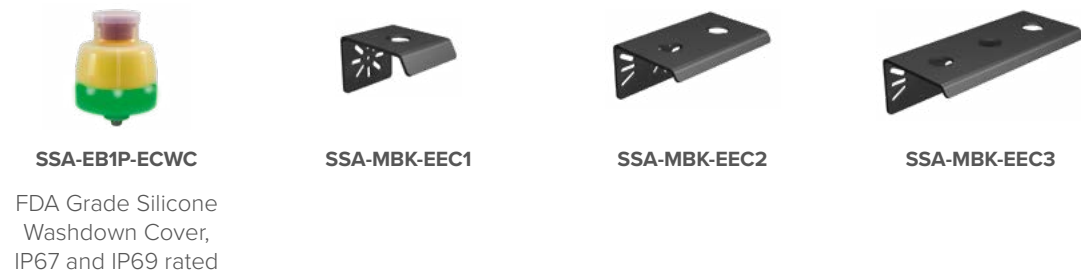

Panel Mount E-Stop Buttons*

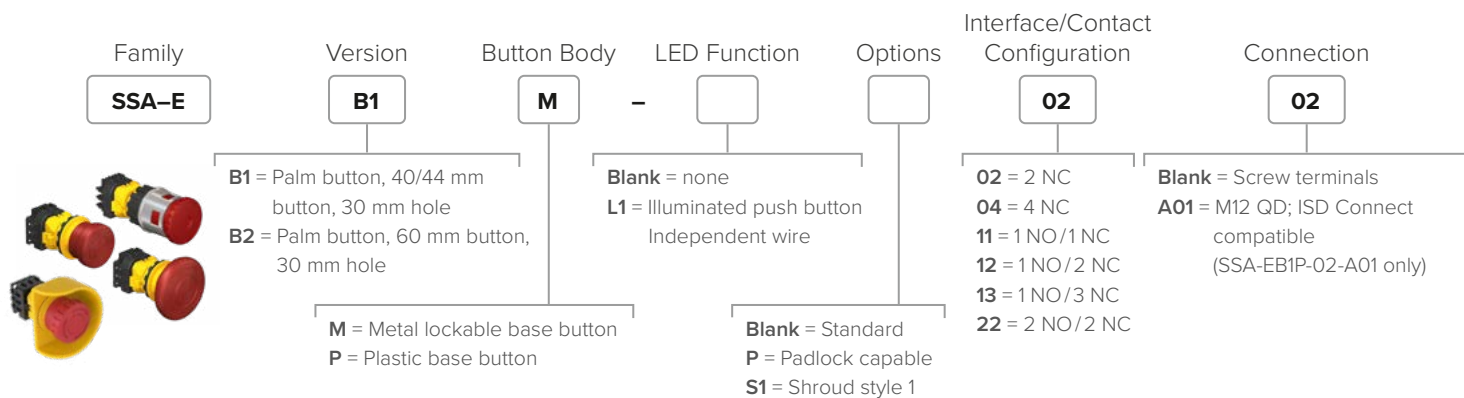

E-Stop Button Kits

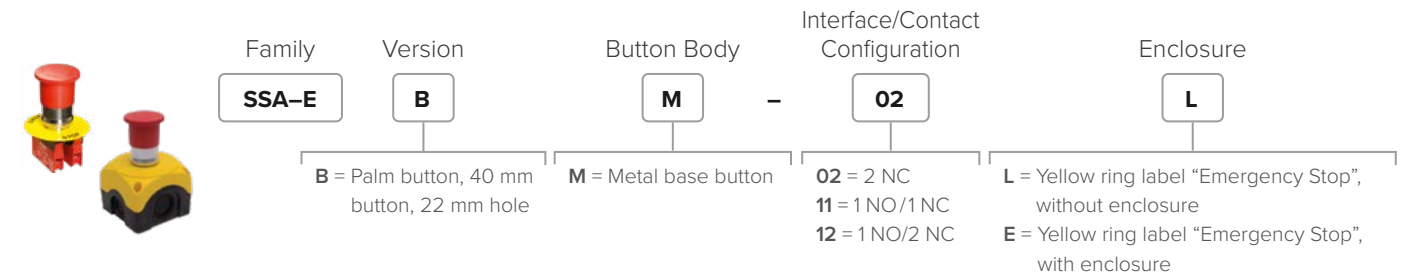

Rope Pull E-Stop Devices

Maximum Rope Length	Rope Connection	Safety Contacts	Auxiliary Contacts	Actuation	Housing Material	Models
38 m	Built-in turnbuckle	2 NC in	2 NO in	Latch	Metal, IP67	RP-RM83F-38LT
75 m						RP-RM83F-75LT
38 m	Ring connection					RP-RM83F-38LR
75 m						RP-RM83F-75LR
25 m	Built-in turnbuckle				RP-LS42F-25LE	
37.5 m					RP-LS42F-38LE	
75 m		RP-LS42F-75LE				

Note: For auxiliary status output models add E to the end of the model number (example, RP-RM83F-38LTE)

Rope Pull Switches

Maximum Rope Length	Rope Connection	Safety Contacts	Auxiliary Contacts	Actuation	Housing Material	Models
25 m	Ring connection	2 NC in	2 NO in	Latch	Plastic	RP-LS42F-25L
37.5 m						RP-LS42F-38L
75 m						RP-LS42F-75L
25 m	Built-in turnbuckle					RP-LS42F-25LF
37.5 m					RP-LS42F-38LF	
75 m					RP-LS42F-75LF	
6 m	-	2 NC in	-	Latch	Metal	RP-QM72D-6L
12 m						RP-QM72D-12L
20 m						RP-QM72D-20L
12 m	-	4 NC in	1 NO in	-	Metal	RP-QMT72F-12L
6 m						RP-QMT72E-12L
6 m						2 NC in
100 m (50 m each side)	RP-LM40D-6L					
			2 NO in	Latch		RP-QM90F-100L

Components for Wire Rope Assembly

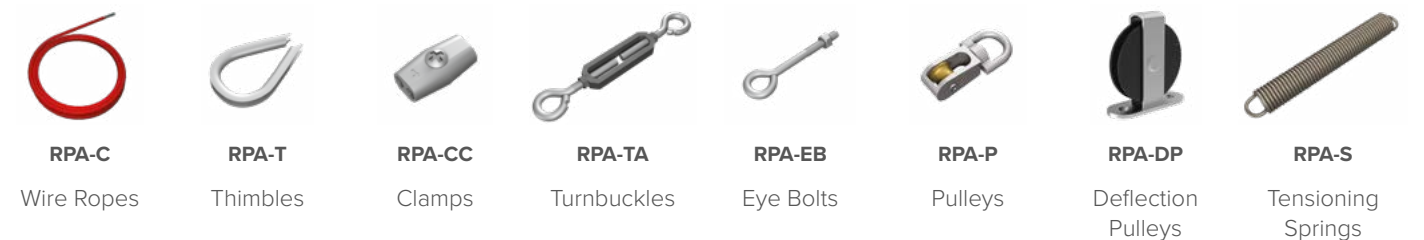

Hardware kits are available (RPAK)

More Sensors, More Solutions.

Banner Engineering designs and manufactures industrial automation products including sensors, smart IIoT and industrial wireless technologies, LED lights and indicators, measurement devices, machine safety equipment, as well as barcode scanners and machine vision. These solutions help make many of the things we use every day, from food and medicine to cars and electronics. A high-quality, reliable Banner product is installed somewhere around the world every two seconds. Headquartered in Minneapolis since 1966, Banner is an industry leader with more than 10,000 products, operations on five continents, and a world-wide team of more than 5,500 employees and partners. Our dedication to innovation and personable service makes Banner a trusted source of smart automation technologies to customers around the globe.

